

UNDERSTANDING CERTIFIED LOCAL GOVERNMENTS IN COLORADO

A Guide for Commissions, Staff, Main Street Communities, Elected Officials and Community Partners



FINAL: AUGUST, 2017



COLORADO
Department of Local Affairs
Division of Local Government



HISTORY  *Colorado*





COLORADO
Department of Local Affairs
Office of the Executive Director



August 2017

Dear Reader:

History Colorado and the Department of Local Affairs are proud to continue our strong and productive partnership. We are continuing to work with local governments across Colorado to secure our cultural heritage for generations to come. The preservation of local community resources and the history they represent is fundamental to a robust future for all Coloradans.

Over the years, we have seen new policies implemented, programs grow, new members join Boards and Commissions, and highly qualified and motivated staff contribute to our mission or move on to new opportunities. With these changes comes a pause—when best practices are reconsidered or passed on to a new generation of preservationists. We believe there is value in creating a one-source document for all to reference and maintain consistency in practice and policy, so we have compiled resources and guidance tools to assist local community partners through a variety of situations and challenges.

We are proud to introduce you to the outcome of that idea: the Understanding Certified Local Governments in Colorado guide—a compilation of material that outlines the processes, rules, and unique aspects of community preservation work written for Commissioners, Main Street communities, elected officials, community partners, and staff. It is designed to walk you through the steps of identifying heritage opportunities in your community, how the Main Street program can engage and encourage the rehabilitation of historic buildings in the commercial core, and how to be an effective member of a preservation commission. It provides guidance on preservation and lists available resources and tools relevant to working as and with your local government.

Consistency in approach is a part of preservation best practice. This guide will help all of us work more efficiently and effectively—together. Information and assistance can make a significant difference to any plan or project, and we hope you find this guide a useful tool to help you be, and remain, successful in your preservation efforts.

Sincerely,

Irv Halter, Executive Director, DOLA

Steve Turner, AIA, Executive Director, History Colorado
State Historic Preservation Officer

TABLE OF CONTENTS

Introduction.....	1
Chapter 1: Background.....	7
A. Introduction.....	8
B. Why Do We Preserve Historic Resources?.....	8
C. Preservation Benefits.....	9
D. What Does Historic Preservation Mean?.....	15
E. What is a Historic Property?.....	16
F. What are Our Goals for Preservation?.....	17
G. How Did We Get Here?.....	20
H. Role of the Commission.....	32
Chapter 2: Working With A Preservation Program.....	33
A. Partnerships.....	34
B. Policy Base of Historic Preservation.....	37
C. Working With Boundaries.....	41
Chapter 3: Nuts and Bolts for Commissions.....	45
A. The HPC and Its Staff.....	46
B. Defensible Decision-Making.....	53
C. Requirements for Continued Certification as a Certified Local Government.....	55
Chapter 4: Identification of Historic Resources.....	57
A. The Preservation Plan.....	58
B. The Survey Plan.....	59
C. Historic Context Statements.....	59
D. Surveys.....	60
E. Inventories.....	65
Chapter 5: Designating Properties.....	67
A. Designating Historic Properties.....	68
B. Significance and Integrity.....	70
C. Types of Historic Properties.....	76
D. Defining Districts and Using Boundaries.....	80
Chapter 6: Treatment of Historic Properties.....	83
A. Determining What’s Important to Preserve.....	84
B. Basic Preservation Principles.....	86

C. Alternative Treatments for a Historic Property.....	87
D. Applying These Principles.....	90
E. Design Guidelines.....	94

Chapter 7: Project Review.....99

A. What is the HPC’s Scope of Authority?.....	100
B. When is a COA Required?.....	101
C. What are the Steps in the Review?	102
D. Citing Design Guidelines	107
E. Potential Actions.....	108
F. Special Project Review.....	108

Chapter 8: Frequent Design Challenges.....111

A. Substitute Materials.....	112
B. Sustainability and “Green” Issues.....	116
C. Windows In Historic Buildings.....	124
D. New Additions to Historic Buildings.....	129
E. New Construction in Historic Districts.....	133

Chapter 9: Incentives for Preservation.....135

A. Incentives for Preservation.....	136
B. Resources That Can Help.....	142

Chapter 10: Legal Foundations.....149

A. Legal Basis.....	150
B. How Do We Find What is Historically Significant?.....	157
C. How Do We Officially Recognize Properties of Historic Significance?.....	162
D. How Does Local Designation Work?.....	165
E. What Legal Issues May Be Raised?.....	166
F. Special Conditions That Ordinances May Address.....	168

Chapter 11: Where Do We Go From Here?.....176

A. Current Trends.....	177
B. Keep Challenges in Perspective.....	179
C. Reaching Out.....	180
D. Your Work is Valued!.....	181
E. Thank You for Your Service!.....	181

Glossary.....182

Appendix.....190

Acknowledgements

Many people provided invaluable assistance on this project. The following individuals contributed to the development of the Operational Guidebook:

Colorado Main Street Program

Shay Coburn, Colorado Main Street Coordinator
Tim Stroh AIA, Main Street Preservation Architect

History Colorado

Mark Rodman, Preservation Technical Services Manager

Reviewers

Abigail Christman, Assoc. City Planner Landmark Preservation, City/County of Denver
Rebecca Goodwin, Otero County Historic Preservation Advisory Board
Betsy Kellums, Greeley Historic Preservation Office
Jennifer Orrigo Charles, Colorado Preservation, Inc.
Julia Puester, AICP, Senior Planner, Town of Breckenridge
Linda Towle, Cortez Historic Preservation Board

Winter & Company

Noré Winter
Julie Husband
Marcia Klopf
Harry Brennan
Christopher Ball
Betsy Shears

Finally, thanks goes to all those members of the Colorado Main Street Program, History Colorado, historic preservation commissions, staff, Main Street Communities, elected officials and community partners who dedicate countless hours of service to their community. Grassroots preservation efforts rely heavily on the dedication of local preservationists who are actively involved in local government activities. Those qualified individuals who serve on local HPCs play a critical role in the protection and enhancement of the state's historic resources, and without their service, much of our heritage would be lost.

Funding for the Project

This project was funded by the Colorado Main Street Program which is supported and administered by the Department of Local Affairs. This project was completed in partnership with History Colorado.

INTRODUCTION

Welcome!

Historic Preservation Commissions (HPCs), serving as part of local governments across the state play invaluable roles in promoting the active, respectful use of historic resources and districts. They help to preserve our heritage and to promote livable, vital places throughout the state.

As of August 2017, Colorado has 123 municipal and county jurisdictions with HPCs established under state enabling legislation. The communities in which commissions operate vary greatly in terms of their size, demographics, financial capacity, regulatory framework, and the resources of the built environment that they work to protect. They also vary to some degree in the ways in which the commissions operate, in terms of the basic tools they use, including their ordinances, surveys and design guidelines. Even so, there are many similarities and lessons learned that can be shared. This guidebook is an important resource for HPCs, their staff, elected officials, and others throughout Colorado communities who are interested in how preservation operates at the local government level. It offers an overview of the key components of a preservation program that commissions use in executing their duties. It is published in the interest of enhancing the performance of preservation work of local governments and to help others understand how to support these programs.

While this guide is a valuable tool for all communities with an HPC, it is a reference specifically for Colorado's Certified Local Governments and Main Street communities. A Certified Local Government (CLG) is a local government having a partnership agreement with the State Historic Preservation Office (SHPO)

USER NOTES

Some important notes when using this guide:

Although this guide provides legal explanations and cites legal authorities, it should not be relied on as a source of legal advice. Members and staff of historic preservation commissions are advised to obtain legal opinions from their county or municipal attorneys should questions arise.

In addition to this guide, History Colorado provides a range of materials to assist local commissions in doing their jobs. Refer to www.historycolorado.org for a list of publications and video materials.

Colorado Main Street also provides a variety of resources including webinars, forms for Main Street managers, annual conference events, and a variety of other documents. Refer to <https://www.colorado.gov/pacific/dola/main-street-resources>.



and the National Park Service (NPS). The local preservation ordinance and Historic Preservation Commission for a CLG must meet certain standards, and this partnership also obligates the CLG to survey and inventory historic resources and to develop historic preservation programs in its community. In a CLG, properties can be protected by design review, communities can receive federal grants, participate in state preservation tax credit programs and are offered training workshops to encourage networking among local governments. Of the 123 Colorado communities that have a preservation ordinance, 59 are CLGs. Eight Main Street communities are CLGs (Central City, Elizabeth, Lake City, Lamar, Leadville, Steamboat Springs, Windsor and Woodland Park), and six Main Street communities have preservation ordinances that are not CLGs (Brush, Lyons, Meeker, Rifle, Trinidad and Victor).

The guide introduces a foundation of basic preservation principles, operating procedures and practical advice that will help new commissioners understand the realm in which they will operate; at the same time, it will help experienced commissioners refine their skills regarding basic concepts, common terminology, and core principles of preservation practice. It also provides an insight into local preservation systems for elected officials and members of other boards (such as planning commissions) who are interested in how HPCs operate. Zoning and building code officers, community development directors and Main Street managers will also benefit from the material, since their duties often bring them into contact with HPCs.

NOTE:

Links in this document are interactive. You may click on the link to be redirected to the website provided. However, in some cases these weblinks may be broken. Titles of the weblinks are provided to assist in searching for documents if the links provided become inactive.

The Need for a Guide

Continuing education is the foundation of a strong historic preservation commission. Not only must commissioners be equipped to fulfill their statutory roles in a responsive and sensitive way, they must also provide leadership for the historic preservation movement at the local level. In order for commissions to effectively carry out their legislative functions and serve as preservation advocates, they must be viewed as credible, trustworthy, and valuable. They must be able to operate in a professional manner and answer basic questions about preservation theory and operations. They also must demonstrate sound decision-making to maintain public trust and confidence. For these reasons, ongoing training is needed on a variety of topics, from preservation basics to more advanced technical issues. The guide is provided in response to these needs.

Moreover, as the field of historic preservation is always evolving, commission members must constantly pursue educational opportunities that enable them to continue to fulfill their duties faithfully and capably. Informed commissioners render more impartial and consistent decisions. They also serve as stronger advocates for local heritage and ultimately bring credit to their commission and to the preservation movement in general.

HPCs may struggle with technical issues related to program activities as well as questions of how to operate efficiently, sometimes with limited staff and short deadlines. They also seek to build a broader base of support by expanding their understanding of operating principles and procedures among the community at large. Sometimes, they are challenged with what may appear to be conflicting policies with other local regulations that may create tension between historic preservation and broader community planning objectives.

All new commissioners are strongly encouraged to review the guide, while more experienced commissioners may use it as a refresher on specific topics. Commissioners, both new and old, can benefit from the guide on a variety of topics, from preservation basics to more advanced



NOTE:

For more information about CLGs, including the benefits, obligations, and certification process, please consult the Colorado Certified Local Government Handbook by visiting: <http://www.historycolorado.org/sites/default/files/media/document/2017/1416.pdf>



technical issues, to carry out their legislative functions and to serve as effective preservation advocates. This requires that commissioners possess a depth of knowledge that enables them to explain to others the importance of historic preservation.

In addition to providing commissioners with information regarding technical issues, relationships with city staff, and a broader knowledge base for their role on the HPC, municipal and county staff are also an important audience for this guidebook. Through this guide, staff may become more informed regarding the operational nature of historic designation, technical strategies, legal challenges, and potential outreach methods that can be applied in their specific communities. In addition, preservation advocates and Main Street groups can gain a better understanding of the role of a CLG through the information provided in the guide, creating a stronger network of preservation proponents throughout Colorado communities.

About The Guides Organization

The guide is designed to be informative while covering a wide range of material. It first presents an overview of how the preservation movement evolved in the United States and within Colorado. Then, it introduces the basic components of a program, the ways in which historic resources are identified, and then officially designated. Next, it addresses the ways in which meetings should be conducted, including design review. Later chapters return to legal and design topics, to explore some of the more frequently occurring questions related to these topics.

Readers will note that some topics appear in more than one chapter, resulting in some repetition. This is intentional. It reflects the integrated nature of the various components that are associated with operating a preservation program at the local level. While many related elements are grouped under one broad section within a single chapter, others appear in more than one place. For example, the use of historic resource surveys is discussed in the section related to identifying resources,

but also in the sections addressing designation, design review and legal issues. In each of those locations the treatment of that topic varies somewhat, in that it is tailored to the broader topic at hand. In this way, a user who is only reading one chapter for a specific topic will see its relationship to other material presented elsewhere in the training materials.

Colorado Main Street and Certified Local Government Programs

As previously mentioned, this guide provides important information for all communities with a preservation ordinance and a Historic Preservation Commission, but focuses on communities that are currently enrolled in the Main Street Program and/or are designated as a Certified Local Government. The Main Street program focuses on revitalizing traditional downtowns and historic commercial districts, and promoting economic development and historic preservation. The Certified Local Government program is a national program, just like the Main Street program, that focuses on local involvement in preservation issues by cultivating a partnership among the Certified Local Government, the State Historic Preservation Office, and the National Park Service. While these two programs are separate and involve individual enrollment and certification, they are very much related and communities can work to coordinate efforts between the two programs; information regarding this coordination is listed throughout this guide. Communities that are currently involved in the Main Street program and those designated as a CLG are illustrated on the following page.

NOTE:

For a list of resources including Comprehensive Plans, Public Involvement, Sustainability Planning, and other useful links, visit:

<https://www.colorado.gov/dola/community-development-planning>

Colorado Main Street Communities

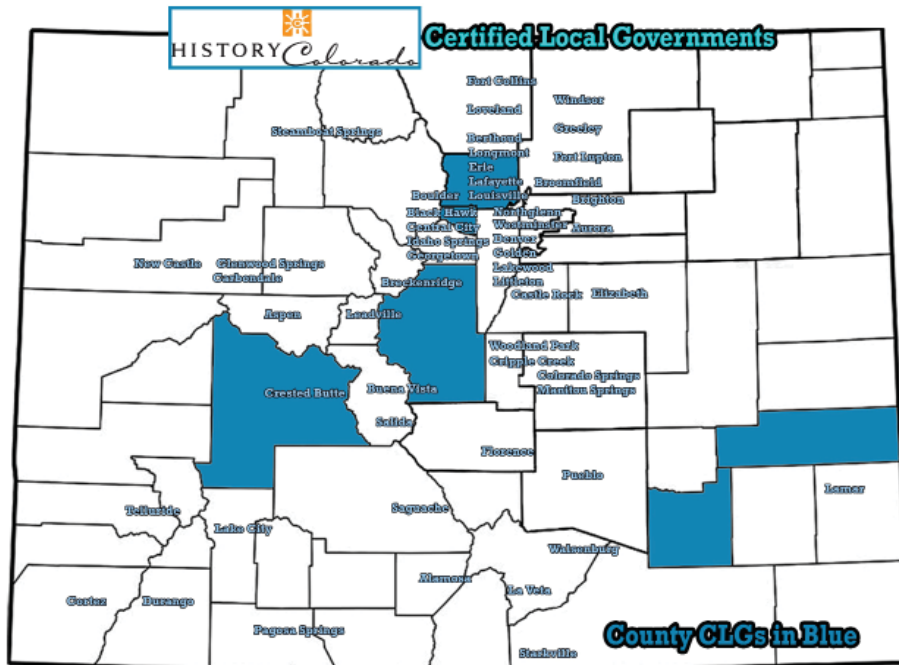
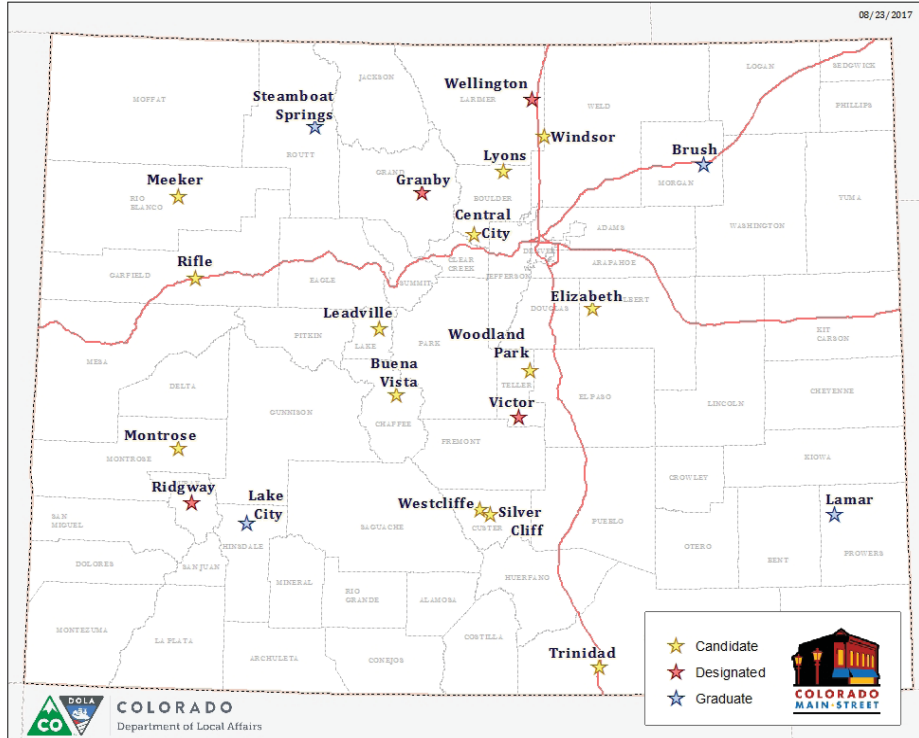

Maps current as of August 2017

CHAPTER 1: BACKGROUND

This chapter provides information about the importance of historic preservation programs in our communities, important terms to understand in order to operate a preservation program, and the variety of benefits that communities can experience through the creation of a historic preservation program. It also presents a history of preservation laws and organizations at the federal, state and local levels, and concludes with the roles of a local historic preservation commission. The information this chapter provides is crucial to understanding the more detailed chapters that follow.

In This Chapter:

- A. Introduction
- B. Why Do We Preserve Historic Resources?
- C. Preservation Benefits
- D. What Does Historic Preservation Mean?
- E. What Is A Historic Property?
- F. What Are Our Goals For Preservation?
- G. How Did We Get Here?
- H. Role Of The Commission



Preservation commissioners serve an essential role in promoting preservation and use of historic resources throughout Colorado.



A. Introduction

With heritage so rich

Local initiatives to preserve our heritage in America date back more than 150 years, but an important milestone occurred in 1966, when a Special Committee on Historic Preservation for the U.S. Conference of Mayors explored the issue of heritage conservation in America. Their report, titled *With Heritage So Rich*, sparked adoption of the National Historic Preservation Act that year. In its introduction, author Sidney Hyman set forth fundamental reasons for preservation that remain valid today:

“What we want to conserve, therefore, is the evidence of individual talent and tradition, of liberty and union among successive generations of Americans. We want the signs of where we came from and how we got to where we are, the thoughts we had along the way, and what we did to express the thoughts in action. We want to know the trails that were walked, the battles that were fought, the tools that were made. We want to know the beautiful or useful things that were built and the originality that was shown, the adaptations that were made and the grace-notes to life that were sounded. We want to know the experiments in community living that were tried and the lessons that were taught by a brave failure as well as by a brave success.”

B. Why Do We Preserve Historic Resources?

We preserve historic resources for these reasons:

- Preservation honors our diverse heritage.
- Preservation supports sound community planning and development.
- Preservation maintains community character and supports livability.
- Preservation supports environmental sustainability in our communities.
- Preservation keeps historic resources for the benefit of future generations.

- Preservation supports economic development.
- Preservation provides educational resources to discover our past and inform our future.

C. Preservation Benefits

Colorado’s historic resources provide tangible links to the past, which enriches our sense of identity and the value of place. They also contribute to several key community objectives including economic development, livability, and sustainability.

Other benefits are less tangible, but nonetheless valuable. The scale and texture in the detail of historic buildings enrich our communities. Experiencing historic buildings also fosters civic pride, and in turn encourages citizen involvement in the community. This promotes improvement of personal property, and active engagement in our cities and towns. It is a means of fostering good citizenship.

The state’s historic resources are essential components of Colorado’s identity. They enhance quality of life, economic vitality, and environmental sustainability. Investment in these assets ensures that the social, cultural, and economic attraction of the state is maintained and enhanced.

Construction quality

Often the quality of early construction was higher than it is today. Lumber came from mature trees, was properly seasoned and typically milled to “full dimensions,” providing stronger framing and construction. Buildings also were thoughtfully detailed and the finishes were generally of high quality—characteristics that owners today appreciate. The quality of construction in earlier buildings is therefore an asset which is impossible to replace.



ECONOMIC BENEFITS

Refer to *Preservation for a Changing Colorado* for more information on the economic benefits of preservation.

<http://www.preservationbenefitscolorado.com>

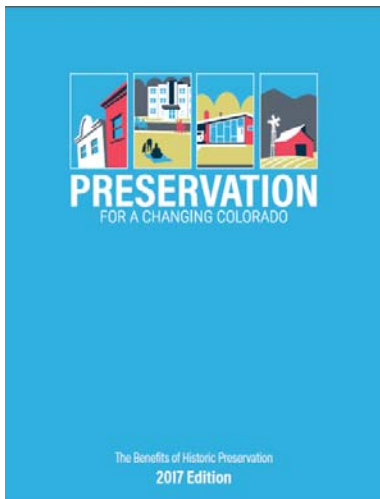

MEASURING ECONOMIC IMPACTS OF HISTORIC PRESERVATION

A report written for the Advisory Council on Historic Preservation identifies various indicators that can be used to measure the economic impact of historic preservation over time. The full report can be read at

<http://www.preserveamerica.gov/docs/economic-impacts-of-historic-preservation-study.pdf>

Adaptability

Owners also recognize that the floor plans of many historic properties easily accommodate changing needs. Rooms in both historic homes and commercial buildings are frequently large, permitting a variety of uses while retaining the overall historic character.

Economic benefits

The economic benefits of investing in historic properties are well documented. Because historic properties are finite and cannot be replaced, they can be precious commodities. Preservation therefore adds value to property. Other benefits center on rehabilitation projects and on the income generated by heritage tourism.

Historic rehabilitation projects

Direct and indirect economic benefits accrue from rehabilitation projects. Direct impact refers to the actual purchases of labor and materials, while indirect impact can be defined as expenditures associated with the project, such as manufacturing labor. These can be added to create the “total” impact. Preservation projects are generally more labor intensive, with up to 70% of the total project budget being spent on labor, as opposed to 50% when compared to new construction. This means that more of the money invested in the project will stay in the local economy and not be used towards materials and other costs manufactured or sourced outside the community. Furthermore, a rehabilitation project will provide functional, distinctive, and affordable space for new and existing small businesses. This is especially relevant to the local economy where many local businesses operate in historic buildings.

Heritage tourism

Heritage tourism is another benefit of investment in historic preservation, as people are attracted to the cultural heritage sites within Colorado. These resources provide visitors a glimpse into history and its contribution to state and national history. Cultural heritage tourism means traveling to experience the places that authentically represent the stories and people of the past and present. It includes cultural, historic, and natural re-



Preserving and adapting a historic structure is sound environmental policy in all respects. In this example, the adaptive reuse of the Ice House in Denver preserves the building, including the energy and resources invested in its construction.

sources. Heritage tourists spend more dollars on travel than other tourists. Heritage tourism also stimulates employment in hotels, bed and breakfasts, motels, retail stores, restaurants, and other service businesses. The Colorado Tourism Office provides more details: <http://industry.colorado.com/overview/hag-committee>.

Economic vitality

Historic preservation is a key factor in maintaining and enhancing local economies. The revitalization of Main Street and the “Main Street Approach” has played a large role in preserving and reinvigorating historic downtowns and neighborhood commercial districts. This approach focuses on the importance of learning about the local economy, its primary drivers and regional context, and integrates community visioning, marketing understanding, transformation strategies and implementation/measurement. These strategies have earned the Main Street program the reputation as one of the most powerful economic revitalization tools in the nation, with over \$65.6 billion in reinvestment, 126,476 new businesses, and 260,011 buildings rehabilitated since 1980. For more statistics regarding the economic impacts of

PRESERVATION AND RIGHTSIZING IN AMERICA

The report, *Managing Change: Preservation and Rightsizing in America*, published by the Advisory Council on Historic Preservation, describes the importance of protecting historic buildings, repurposing land, preserving neighborhoods, redeveloping downtowns, and connecting historic resources to regional plans, in a time where America is seeing the need to transition cities and their existing resources into healthy communities that meet the needs of the 21st century. Historic assets play an extremely important role in this transition process, as those that are preserved and reused are the foundation for the future. To read the full report, visit

<http://www.achp.gov/RightsizingReport.pdf>



the Main Street program, visit <http://www.mainstreet.org/mainstreetimpact>. To learn more about the Main Street Approach, visit <http://www.mainstreet.org/mainstreetamerica/theapproach>.

Environmental benefits

Sustainable development and the conservation of resources are inherent central principles of historic preservation. Sensitive stewardship of the existing building stock reduces our environmental impact. Preserving and adapting a historic structure is sound environmental policy in all respects. In basic terms, re-using a building preserves the energy and resources invested in its construction, and removes the need for producing new construction materials.

Embodied energy

Embodied energy is defined as the amount of energy included to create the original building and its components. Preserving a historic structure retains this energy. According to the Environmental Protection Agency, building debris constitutes around a third of all waste generated in the country. This can be reduced significantly if historic structures are retained rather than demolished. Investment studies confirm that the loss of embodied energy associated with the replacement of an existing, unimproved building would take three decades or more to recoup from the reduced operating energy costs in a new building. Wood, stone, brick, and glass all manifest the energy investment of their creation and the energy invested in building construction. If demolished, this investment in embodied energy is lost and significant new energy demands are required to replace it.

Sustainable building materials

Historic building construction with the durable traditional materials of wood, stone, and brick were built for longevity, in a manner that allows for repairs to be conducted easily.

The sustainable nature of historic construction is best illustrated by the design and construction of a window. Historic windows can be repaired through reglazing and

the patching and splicing of wood elements. Contemporary windows are often difficult to repair, with replacement as the only option. If a seal is disturbed in a vinyl window the best approach is to replace that particular window, rather than repair the part, as is the case for a historic wood window. Older windows were built with well seasoned wood from stronger, durable, weather resistant old growth forests.



Building energy savings

Energy savings are not usually achieved by replacing original building fabric with contemporary alternatives. Repair and weatherstripping or insulation of the original elements is more energy efficient and much less expensive. As much as 50% of the energy lost from a house is from air infiltration through the attic, uninsulated walls, and around the windows and door cavities, and not through the glazing of windows and doors. Proper caulking and insulation around windows and doors, combined with adding insulation in attic space, will save energy at a higher rate than by replacing single paned wood windows with double or triple paned alternatives.



As governments across the state develop more focused sustainability programs, the environmental benefits of preserving historic building materials will become even more important. It is essential that preservation advocates actively participate in policy development along these lines.

Sustainable growth

Historic preservation supports Sustainable Growth principles. It reduces the demand for creating new building materials, and “recycles” existing materials in place. In addition, historic neighborhoods and downtowns tend to be pedestrian, bicycle and transit-friendly, reducing the need for automobile trips. Frequently developed with a mix of densities and uses, these neighborhoods and communities offer residents the option to walk or take transit to work, school, shop, or play. Historic communities can provide needed housing for all income levels. Without developing new infrastructure, historic properties may be rehabilitated and updated at lower costs than building in new suburban tracts. Through new



businesses, shops, and housing in existing buildings, the local tax base is enhanced while the use of existing infrastructure is maximized.

Livability

All of these benefits add up to an enhanced quality of life for residents. This equates to a livability factor that is highly valued. Living in walkable neighborhoods with convenient goods and services are often qualities of historic downtowns and older neighborhoods.

The benefits of preservation in Colorado

The benefits of preserving historic resources is a subject of extensive study across the nation, including Colorado. Many states have published findings related to the benefits on property values, job creation and the economy in general. In Colorado, the report, *Preservation for a Changing Colorado: The Benefits of Historic Preservation (updated 2017)*, provides substantial documentation. This includes many of the benefits mentioned above, with a focus on the state. While this document is currently a highly recommended report to consult, the reader is advised to always check the History Colorado website or contact staff for the latest economic reports and available documents. The report summarizes these benefits in three categories:

Preservation creates jobs.

Approximately 32 new jobs are generated for every \$1 million spent on the preservation of historic buildings. Since 1981, historic preservation projects in Colorado have created almost 35,000 jobs and generated a total of nearly \$2.5 billion in direct and indirect economic impacts. Acquisition and development projects supported by State Historical Fund grants have leveraged approximately \$3 million in additional funds for each \$1 million in grant funding, meaning that public investment in preservation is paying off for Colorado. In addition to creating jobs and income, preservation also is a key driver behind the state's powerful tourism industry, providing interesting and unique historic destinations for visitors in every corner of the state, from Durango to Sterling, and from Steamboat Springs to Rocky Ford. In one year

alone (2008), heritage tourism in Colorado generated \$244 million in visitor spending.

Preservation builds strong communities.

Designation of local historic districts stabilizes and strengthens neighborhoods by protecting their character, typically enhancing property values as a result. Preservation programs also foster community pride, learning, and creativity, thus making historic neighborhoods desirable places to live and work. Beyond protecting history and improving aesthetics, preservation also creates cultural vitality and defines community identity, which helps communities attract visitors and engage volunteers.

Preservation protects the environment.

Preservation is a natural partner with sustainable development and environmental stewardship. Through preservation, communities are able to address many environmental goals such as conserving energy, reducing waste, curbing sprawl, and improving air quality. In fact, one of the most environmentally-friendly development practices is the decision to repair and reuse an existing building, rather than replace it, especially when considering the overall life-cycle costs and energy use of the building.



D. What Does Historic Preservation Mean?

While we all talk about “preservation,” we don’t often define it. Here is a suggestion: Fundamentally, preservation means keeping historic properties and places in active use while accommodating appropriate improvements to sustain their viability and character. It also means keeping historic resources for the benefit of future generations. That is, while maintaining properties in active use is the immediate objective, this is in part a means of assuring that these resources will be available for others to enjoy in the future.

Preservation also is about managing change, not freezing properties or districts in time. It also is not simply about maintaining a historic appearance; it is about authenticity, which involves - where possible - keeping the original materials and craftsmanship of historic properties intact.



Historic preservation encompasses the breadth of activities aimed at preserving national heritage as represented by a wide variety of cultural resources. Preservation can include: acquisition, development, and adaptive use of historic properties; comprehensive planning and disaster planning; research of historic contexts; survey, inventory, evaluation, and designation of historic properties; management, including treatments such as preservation, stabilization, rehabilitation, restoration, and reconstruction; and education and interpretation. It may also include appropriate additions to historic buildings.



Main Street and preservation

For the Colorado Main Street program, preservation is a key tool to assist communities in revitalizing their downtowns, which frequently have a high concentration of historic resources. It includes rebuilding of central business districts based on the traditional assets of each community's unique architecture, character and local ownership.



E. What Is A Historic Property?

In preservation terms, a “property” may be a prehistoric or historic site, building, structure, district, cultural landscape or object that has been determined to have historic significance, by applying criteria that are adopted by the governing body. Generally, a historic property is one that is associated with an activity or person of importance in the community's history, or that represents a noteworthy designer, is a type of building construction



that is important in the area’s history, or is a site that may yield information about a community’s pre-history or history. More information about historic properties, significance and integrity can be found in Chapter 5, “Designating Properties”.

F. What Are Our Goals For Preservation?

National Historic Preservation Act of 1966

Goals for preservation are outlined in the National Historic Preservation Act of 1966. While crafted for federal agencies, they also reflect objectives for local governments in Colorado. As stated in the preamble of the NHPA:

“The Congress finds and declares that –

(1) the spirit and direction of the Nation are founded upon and reflected in its historic heritage;

(2) the historical and cultural foundations of the Nation should be preserved as a living part of our community life and development in order to give a sense of orientation to the American people;

(3) historic properties significant to the Nation’s heritage are being lost or substantially altered, often inadvertently, with increasing frequency;

(4) the preservation of this irreplaceable heritage is in the public interest so that its vital legacy of cultural, educational, aesthetic, inspirational, economic, and energy benefits will be maintained and enriched for future generations of Americans;

(5) in the face of ever-increasing extensions of urban centers, highways, and residential, commercial, and industrial developments, the present governmental and nongovernmental historic preservation programs and activities are inadequate to insure [sic] future generations a genuine opportunity to appreciate and enjoy the rich heritage of our Nation;





COLORADO STATE PRESERVATION PLAN

Refer to *The Power of Heritage and Place: A 2020 Action Plan to Advance Preservation in Colorado* for more information on statewide preservation goals.

Refer to page 5 of the plan *The Power of Heritage and Place*, for more information on preservation goals and strategies.

<https://www.historycolorado.org/state-preservation-plan>

(6) the increased knowledge of our historic resources, the establishment of better means of identifying and administering them, and the encouragement of their preservation will improve the planning and execution of Federal and federally assisted projects and will assist economic growth and development..."

Colorado Preservation Plan goals

Goals for preservation are further defined in the Colorado State Preservation Plan, *The Power of Heritage and Place*. With the preservation community united in its stewardship of Colorado's resources, several goals are outlined in the document:

GOAL A: Preserving the Places that Matter

- The ongoing identification, documentation, evaluation, protection, and interpretation of Colorado's irreplaceable historic and cultural resources

GOAL B: Strengthening and Connecting the Colorado Preservation Network

- The building of the capacity of preservation partners and networks statewide to nurture local leaders and leverage assets

GOAL C: Shaping the Preservation Message

- The promotion and messaging of historic preservation's mission and vision to all citizens

GOAL D: Publicizing the Benefits of Preservation

- The documenting and sharing of the benefits of historic preservation

GOAL E: Weaving Preservation Throughout Education

- The education of students and citizens of all ages about their shared heritage

GOAL F: Advancing Preservation Practices

- The provision of historic preservation technical outreach to assist in defining, describing, and preserving Colorado's historic and cultural resources

In *The Power of Heritage and Place*, more specific actions related to preservation are listed:

BY THE YEAR 2020...

- The public's definition and understanding of preservation will build on a positive connotation through personal experience and hands-on interaction with local resources.
- More Coloradans will self-identify as preservationists through the effort to communicate how preservation relates to each individual.
- Cultural resources in their many forms—the built environment, landscapes, archaeological sites, collections, archives, language, folkways, dance, and other expressions—will be widely recognized and celebrated by all citizens as a source of pride.
- An aggressive survey effort will have yielded a greater understanding of the cultural landscape of our state.
- Property owners, locally elected officials, chambers of commerce, educators, conservation organizations, and other non-traditional partners will join Colorado's larger preservation network.
- Coloradans will fully understand and demand the economic benefits of preservation, such as job creation, energy conservation, heritage tourism, and local stimulus.
- Regional decision-making will be informed through education, survey, and identification to advance sensitive and balanced stewardship of and planning for historic resources.
- Local and regional networks of advocates will encourage, assist, and celebrate one another's preservation successes.
- Preservation will enrich educational opportunities for all through interpretation, storytelling, visitation to historic sites, and participation in other cultural experiences, festivals, and demonstrations.
- Citizens will be more aware of threatened and under-represented resources and how they can be protected.
- Sites will benefit from a collaborative approach to understanding layers of significance relating to a larger context, to include team-based interdisciplinary documentation, the gathering of oral histories, and an investigation of material culture.





G. How Did We Get Here?

Historic preservation activities are undertaken by a broad and interconnected web of federal, state, and local governmental agencies and the private sector. This network evolved from a small group of private organizations dedicated to the preservation of individual properties and expanded into a larger system of government protectors and local advocates. Active preservation of historic resources has a long-standing heritage in America. It is a time-proven tool.

This section summarizes some of the events in the preservation movement that have led us to the current state, beginning with early actions at the local level and then progressing to state and federal ones leading up to the adoption of the National Historic Preservation Act and subsequent related laws, including the federal tax credit act. It also includes information on Main Street programs and non-profit preservation programs.

National-level Main Street Program activity

1977: Main Street Project

The National Trust for Historic Preservation launched the three year demonstration project called the Main Street Project.

1980: The Main Street Program

The Main Street Program established as a program for the National Trust for Historic Preservation. The program consisted of six participating states: Colorado, Georgia, Massachusetts, North Carolina, Pennsylvania, and Texas.

2013: The National Main Street Center

Launched as an independent subsidiary of the National Trust for Historic Preservation.

2015: Main Street America

National Main Street Center launched a new brand “Main Street America”. A pilot program, of which Colorado is a participating member, was simultaneously launched to refresh the approach originally developed in 1980.

Colorado-level Main Street Program activity

1980: National Main Street Demonstration Program

Colorado participates in the new program. The communities of Delta, Durango, Grand Junction, Manitou Springs, and Sterling were part of this original program.



2011: Restart of Program

Colorado Department of Local Affairs (DOLA) begins oversight of the Colorado Main Street Program.

2015: National Main Street Refresh Pilot Program

The communities of Brush!, Lake City, and Steamboat Springs participate in this pilot project, with the Colorado Main Street Program as the State Coordinator.



Other related non-profit preservation programs

Early preservation activities focused on individual properties within a city or region. The following list presents examples of preservation programs that have made a difference in the community:

1853: Mount Vernon Ladies' Association

Created by Ann Pamela Cunningham to save the home of George Washington, the Mount Vernon Ladies' Association of the Union served as a model for other preservation projects and organizations that have followed.



1889: Association for the Preservation of Virginia Antiquities (now Preservation Virginia)

Founded as the first statewide preservation organization.





1905: Gunnison County Historical Society
Formed to promote preservation in Gunnison County.

1910: Society for Preservation of New England Antiquities (now Preserve New England)
Established to preserve individual properties of noteworthy significance, focusing on Boston and other cities in New England.



1926: Colonial Williamsburg Foundation
Established as a private, not-for-profit institution that managed the restoration of the historic Williamsburg site; continues today with reenactments and educational programs.

1946: McClellan Players
Formed in Georgetown, Colorado, to raise money to restore buildings. Their first rehabilitation project was the restoration of the Star Hook and Ladder Building.

1949: National Trust for Historic Preservation Creation and Purpose (63 Stat. 927, 16 U.S.C. 468 as amended):
Provided for the creation of the charitable, educational, and nonprofit corporation known as the National Trust for Historic Preservation.



1959: Tread of Pioneer Museum
Established in Routt County to promote preservation.

1970: Historic Denver
Formed and purchased the Molly Brown House and began restoration.

1970: The Georgetown Society (now Historic Georgetown, Inc.)
Formed to promote preservation in Georgetown.

1971: Historic Boulder
Formed to save the Highland School.

1972: Golden Landmarks Association
Founded to preserve historic places in Golden and provide education about Golden's rich and wonderful history.

1972: Poudre Landmarks Foundation

Formed to preserve, restore, protect and interpret the architectural and cultural heritage of the Fort Collins area.

1984: Colorado Preservation, Inc.

Organized to promote preservation statewide.

1997: Historic Routt County!

Founded to preserve historic buildings and sites and to educate the public in historic preservation.

1999: Historic Preservation Alliance of Colorado Springs

Formed to promote preservation in the Colorado Springs area.

2001: Historic Pueblo, Inc.

Formed to promote preservation in Pueblo, with the first task of lobbying and testifying before Pueblo City Council to pass a preservation ordinance.

2001: Historic Greeley, Inc.

Organized to preserve and maintain the area's historic architectural resources.

2006: Breckenridge Heritage Alliance

Formed to promote and protect Breckenridge's unique heritage.



FOR MORE INFORMATION

See the Colorado Office of Historic Preservation (OHP)

<https://www.historycolorado.org/preserve>



Early local preservation ordinances in the United States and in Colorado

While non-profit associations were forming to preserve individual properties of historic value, no local government had passed a regulation requiring preservation of local landmarks, and indeed districts, until Charleston, South Carolina enacted its first ordinance in 1931. In the 1960s and '70s, several governments in Colorado adopted ordinances following the establishment of NHPA that established local preservation commissions and provided for designating and protecting historic properties. The following list is not exhaustive, but provides some examples of milestones in Colorado and nation-wide that helped shape the preservation community.

1931: Charleston, SC

Enacted the first local preservation ordinance in America.

1936: Vieux Carré, New Orleans

Amended state constitution to protect the French Quarter.

1953: Annapolis, MD

Adopted local ordinance.

1967: Denver, CO

Enacted preservation ordinance.

1968: Fort Collins, CO

Adopted its first preservation ordinance.

1970: Georgetown, CO

Enacted Colorado's first preservation ordinance with design review.

1973: Telluride, CO

Adopted preservation ordinance.

1974: Boulder, CO

Adopts its first preservation ordinance.

1978: South of Second Associates v. Georgetown (Colorado Supreme Court Ruling)

This upheld the Georgetown preservation ordinance, and called for more clearly delineating design review areas.



1978: The Penn Central Transportation Company v. New York City (U.S. Supreme Court Ruling)

Upheld the NYC Landmarks Law, saying that it did not constitute a taking of property and that a local commission has the right to regulate a property.

1981: Central City, CO

Adopted preservation ordinance.

State level activity

Officials soon recognized the need for a state-chartered office to promote preservation. Early preservation efforts by the state were actions on a case-by-case basis as a result of citizen advocacy to save specific resources.



Colorado State Laws

1879: COMPILED LAWS 1921:8218 (House Bill 134)

Established the Colorado Historical and Natural History Society (now History Colorado), and authorized the creation of a state museum.

1953: HISTORICAL MONUMENTS ACT (CRS 24-80-501 & 502; SB 53-84)

Mandated the Colorado Historical Society (History Colorado) acquire historical sites and declare them monuments. It also calls for the survey of all historical sites in Colorado and the development of a long range plan for their preservation. <https://www.historycolorado.org/permits-statutes-regulations>

1967: Historical, Prehistorical, and Archaeological Resources Act (CRS 1967: 131-12-1 to 10; HB 67-1475)

Colorado's first antiquity act. It claimed title to historical, prehistorical, and archaeological resources on state-owned lands, and assigned authority to the Colorado Historical Society (History Colorado) to issue or deny permits for survey and excavation and to enter into agreements regarding construction projects, including cooperative projects on private land.



1973: HISTORICAL, PREHISTORICAL, AND ARCHAEOLOGICAL RESOURCES ACT (CRS 24-80-401 to 410; HB 73-1569; 8CCR-1504-7)

Repealed and re-enacted the 1967 act with the addition of creating the office of the state archaeologist, establishing a permit system for archaeological survey and excavation, provisions for salvage archaeology, extending state ownership to antiquities on lands owned by political subdivisions of the state, and adding injunctive authority. <https://www.historycolorado.org/permits-statutes-regulations>

1974: LOCAL GOVERNMENT LAND USE CONTROL ENABLING ACT (CRS 29-20-101; HB 74-1034)

Gives broad authority to plan for and regulate the use of land, with no restrictions, conditions, or procedures prescribed for local governments. Each local government within its respective jurisdiction has the authority to plan for and regulate the use of land by a number of factors, including preservation of areas of historical and archaeological importance.

1974: “1041 Powers” (CRS 24-65.1-101; HB 74-1041)

Allows local governments to identify, designate, and regulate (through a permitting process) 21 statutorily defined “areas and activities of state interest,” including historical and archaeological resource areas.

1975: REGISTER OF HISTORIC PLACES (CRS 24-80.1-101 to 109; HB75-1561)

Provided for the creation of the State Register of Historic Properties. <https://www.historycolorado.org/permits-statutes-regulations>

1990: Colorado State Historic Preservation Tax Credit (CRS 39-22-514; HB 90-1033)

Established the state tax credit for the rehabilitation of qualified historic buildings

1990: Concerning County Ordinance Authority (CRS 30-11-107; HB 90-1104)

Enables counties to designate landmarks and establish historic preservation commissions.

January 3, 1991: ARTICLE XVIII, SECTION 9, COLORADO CONSTITUTION (amendment) created the State Historical Fund at the same time as allowing limited gaming in the towns of Cripple Creek, Central City, and Black Hawk. The amendment directs that a portion of the gaming tax revenues be used for historic preservation throughout the state.

2014: Colorado Job Creation and Main Street Revitalization Act (CRS 39-22-514.5; HB 14-1311)
Updated the Colorado State Historic Preservation Tax Credit to provide a more robust incentive for the preservation of unique historic assets

Federal and national preservation activity

Over the years, many federal actions have contributed to the preservation movement, while others sometimes created threats to older and historic properties. Some key dates are:

1889: Goodman Point Cabinet Order

This Department of the Interior order withdrew the area surrounding Goodman Point Pueblo (Hovenweep National Monument, Montezuma County) from homesteading. This was the first federal action to protect archaeological resources in the United States of America.

1892: Casa Grande Ruin Reservation, Arizona

Through presidential order, set aside the first pre-historic and cultural reserve in the U.S. (now Casa Grande Ruins National Monument)

1906: American Antiquities Act (54 U.S.C. 320301 to 320303; PL 59-209)

Protects archaeological and paleontological resources on federal land from appropriation, injury, or destruction. It establishes a permit system and penalties, orders collections placed in museums, enables rule making, and authorizes the creation of National Monuments.

<http://www.nps.gov/history/local-law/anti1906.htm>

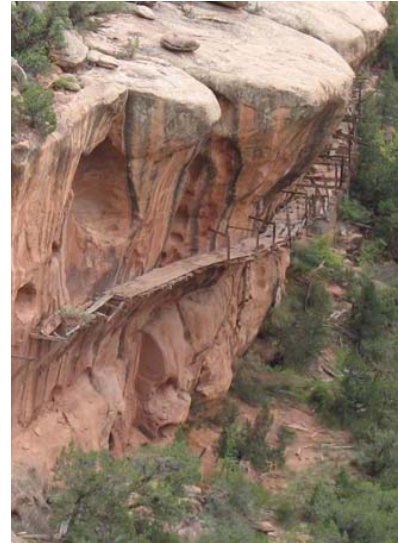

1906: Mesa Verde National Park

Established first National Park to preserve cultural resources and first with the mission to “preserve the works of man”.

1935: National Historic Sites Act (54 U.S.C. 320101 to 320106; PL 74-292)

Established the National Historic Landmarks (NHL) program and authorized the Secretary of the Interior to administer it. The program recognizes nationally significant buildings, sites, and objects that represent the prehistory and history of the United States and encourages their long-range preservation.

1949: Housing Act of 1949 (PL 81-171) and the 1954 Housing Act (PL 83-560)

Title One of the Housing Act of 1949 kick-started the “urban renewal” program that would reshape American cities. The Act provided federal funding to cities to cover the cost of acquiring areas of cities perceived to be “slums”. This increased pressure to demolish older properties, including those of historic significance. The Housing Act of 1954 established urban renewal, which encouraged demolition of older neighborhoods to construct new housing by among other things, providing FHA-backed mortgages.

1956: Federal Aid Highway Act (PL 84-627)

Popularly known as the National Interstate and Defense Highways Act, the legislation empowered state and federal governments to acquire rights-of way for highways throughout America, often impacting older neighborhoods.

1966: National Historic Preservation Act (54 U.S.C. 300101 to 307108; PL 89-665)

Created the National Register of Historic Places, established grant programs for restoration projects and survey activity, and required review of federally funded, licensed, and permitted projects for impacts on historic properties. The act also provided that each state, tribe and territory should establish a Historic Preservation Officer to help administer the law in their individual jurisdictions, and it established the Advisory Council

on Historic Preservation to serve as a presidential and congressional advisor on historic preservation matters.

1969: National Environmental Policy Act (42 U.S.C. 55-4321 to 4370m; PL 91-190)

Requires federal agencies to assess the environmental effects, including impacts to cultural and natural aspects of our national heritage, of their proposed actions prior to making decisions. This assessment can be completed via Environmental Assessments (EAs) or Environmental Impact Statements (EISs) which are sometimes required, depending on the proposed projects, and are the most visible NEPA requirements. http://www.nps.gov/history/local-law/fhpl_ntlenvirnpolcy.pdf

1976: American Revolution Bicentennial

The Bicentennial spurred new interest in history and historic properties. This period saw a surge in local governments establishing preservation commissions.

1979: Archaeological Resources Protection Act (16 U.S.C. 470aa-mm; PL 96-95):

Defines archaeological resources, improves law enforcement, increases criminal penalties for harm or destruction of resources, and allows for civil penalties. It also encourages increased cooperation between the public, professional archaeologists, and government authorities. <https://www.nps.gov/archeology/tools/laws/arpa.htm>

1980: Certified Local Government Program (54 U.S.C. 302501 to 302505; PL 96-515; HR 5496)

The Certified Local Government Program (CLG) is a preservation partnership between local, state and national governments focused on promoting historic preservation at the grass roots level. Established as an amendment to the National Historic Preservation Act, the program is jointly administered by the National Park Service (NPS) and the State Historic Preservation Offices (SHPOs) in each state, with each local community working through a certification process to become recognized as a CLG. CLGs then become an active partner in the Federal Historic Preservation Program and the opportunities it provides.

1981: Tax Reform Act of 1981 (PL 97-34; HR 4242)

Provided a package of tax and budget reductions that encouraged economic growth through reductions in individual tax rates, the expensing of depreciable property incentives for small businesses, and incentives for savings and other purposes. This Act also established the Historic Rehabilitation Tax Credit.

1990: Native American Graves Protection and Repatriation Act (25 U.S.C. 32-3001 to 3013; PL 101-601; HR 5237)

Provides a process for museums and Federal agencies to return certain Native American cultural items - human remains, funerary objects, sacred objects, or objects of cultural patrimony - to lineal descendants, and culturally affiliated Indian tribes and Native Hawaiian organizations. NAGPRA includes provisions for unclaimed and culturally unidentifiable Native American cultural items, intentional and inadvertent discovery of Native American cultural items on Federal and tribal lands, and penalties for noncompliance and illegal trafficking.

Key Preservation Players in Colorado

	Governmental	Private Sector
National Level	National Park Service	National Trust for Historic Preservation
	Advisory Council on Historic Preservation	National Alliance for Preservation Commissions
		Preservation Action
		Archaeological Conservancy
		National Main Street Center
State Level	History Colorado: State Historic Preservation Office	Colorado Preservation, Inc.
		Colorado Historical Foundation
	Colorado State Historical Fund	Colorado Archaeological Society
	Colorado Main Street Program	
Local Level	Local Historic Preservation Commissions	Local Preservation Organizations
	Local Main Street Programs	Historical Societies



H. Role of the Commission

How do local commissions fit into the state's historic preservation system? Clearly, local governments were pivotal in creating the preservation movement, and thus commissioners play a crucial role in promoting good stewardship and the active use of historic properties.

The official roles and responsibilities are defined in local ordinances, but in general, commissions help to identify historic resources by sponsoring surveys and then promote their recognition by publishing inventories of the resource results. They often will then work to have some of these resources designated as official landmarks and districts through local ordinances. Once properties are designated, alterations and improvements are reviewed for appropriateness by the commissions. Commissions also partner with the State of Colorado to review State Historic Preservation Tax Credit projects and National Register of Historic Places Nominations and to participate in Section 106 Review.

In addition to these formal administrative and regulatory roles, commissions work to promote good stewardship by sponsoring educational programs that build awareness of heritage and enhance skills in rehabilitation techniques. Other commission activities may include managing a markers program, presenting awards for meritorious preservation work and staging special events that highlight historic resources.

Commissions also build partnerships with other allied groups and individuals, such as the local Main Street program, economic development offices and local historical societies to promote appreciation of historic resources and to encourage their continued use.

More information about commission roles, partnerships and specific programs is included throughout this guide.

CHAPTER 2: WORKING WITH A PRESERVATION PROGRAM

This chapter first describes how preservation programs operate within broader community activities related to livability and quality of life and then outlines the policies on which the specific components of a preservation program are based. It also highlights some of the partnerships that may exist with other groups and organizations who may use preservation as a means of achieving their own objectives. This sets the stage for the more technical chapters that follow.

In This Chapter:

- A. Partnerships
- B. Policy Base of Historic Preservation
- C. Working with Boundaries





PROGRAM MANUAL



COLORADO PRESERVATION GOALS

For more information about the Colorado Main Street Program, including how to become a Main Street community, visit:

<https://www.colorado.gov/pacific/dola/main-street-communities>

A. Partnerships

Historic Preservation Commissions play a major role in promoting preservation in their communities, but they are not alone. Many form alliances with other partners who share common goals. It is important that commissioners recognize these opportunities to work cooperatively with other groups and individuals such that each can benefit from the synergistic potential of sharing resources. Some of the key partnership opportunities that exist are outlined below.

Colorado Main Street programs

Colorado Main Street programs, as well as other towns with downtown revitalization initiatives, are ideal partners in promoting preservation. Main Street programs may seek to assist property owners in improving their buildings through training, promotion of projects, partnerships to secure financial assistance and advocacy of best design practices. An example might be helping to advocate or assist in obtaining the Certificates of Appropriateness for projects that are subject to design review under local ordinances. Training in relation to design, building, or zoning codes, and historic preservation are typically in line with CLG requirements.

Economic development programs

Main Street programs certainly are key partners in economic development, but other agencies can be as well. A city economic development office, a renewal authority or county extension office are examples. City preservation offices often collaborate in helping to identify space for commercial enterprises in historic buildings, and help to support business recruitment initiatives by highlighting the enhanced quality of life that historic districts in the community offer.

Affordable Housing programs

Local housing authorities and affordable housing advocates are also good partners. Many historic resources offer opportunities to be adapted to multifamily housing, and even larger homes in traditional residential districts may be appropriate for including accessory dwelling units. Some cities are even pro-

moting a “carriage house” program in single family districts to moderately increase housing supply in close-in neighborhoods.

Creative Districts program

The Colorado Creative Districts Program is a related partner. Focusing on highlighting the arts, heritage and design, the program helps to promote a community’s unique identity and enhance areas as appealing places to live, conduct business and attract visitors.

Sustainability offices

Most sustainability programs focus on environmental issues, including energy conservation and generation, but the “recycling” of existing buildings by keeping them in use is a strategy that fits well with greening initiatives. As communities develop more plans for sustainability and resiliency, the role that historic resources will play will be important.

Alternative transportation advocates

As communities work to increase use of alternative modes of transportation, including walking, bicycling and using transit, historic downtowns and close-in neighborhoods are recognized as key. These places typically are more walkable, because of their scale and also the visual interest they offer. Promoting preservation of these places helps keep them viable and supportive of alternative modes.

Conventions and visitor bureaus/tourism groups

Establishing a relationship with local visitor bureaus and tourism groups can facilitate an interest in preservation in the local community as well as visitors from around the state, country, and possibly even the world. Working with visitors bureaus to distribute brochures and information regarding historic resources in a community is a good way to reach new and ever-changing audiences. These groups may also already have established tours or cultural events that could include information about historic properties in the area, establishing a heritage tourism based program.

COLORADO CREATIVE DISTRICTS

OVERVIEW

A division of the Colorado Office of Economic Development, Colorado Creative Industries (CCI) is proud to administer the Colorado Creative District Program. The Creative District enabling legislation passed in 2011 (HB11-1032) and in 2013 (HB13-1208) offers vetted districts access to grant funding, tailored technical assistance, networking and training programs and access to advocacy tools. The Brantner Foundation is a partner of the CCI in establishing the Colorado Creative Districts Program. Since July of 2012, CCI has supported the development of Creative Districts across the state to:

- Create hubs and clusters of economic activity
- Promote a community's unique identity
- Enhance areas as appealing places to live, conduct business and attract visitors

6 CREATIVE ECONOMY ENTERPRISE HUB-CENTERS

Design | Film & Media | Library & Publishing | Performing Arts | Visual Arts & Crafts | Heritage

SNAPSHOT OF COLORADO'S CREATIVE DISTRICTS

\$894M Creative Industry Earnings	13,098 Creative Workforce	2.8M Visitors
---	-------------------------------------	-------------------------

Learn more at www.coloradocreativeindustries.org/creativedistricts





Health care providers

Local hospitals and health care organizations also may be opportunities for partnerships. Increasingly, these groups are seeking ways to promote active outdoor exercise, and historic walking tours can be ideal venues for this. In some communities, health care organizations have teamed with local Main Street programs and preservation commissions in establishing “healthy heritage walks.”

Local preservation organizations

Partnering with local preservation organizations such as Historic Denver and Historic Boulder are key connections to building a strong preservation community. Local preservation organizations can be especially helpful when planning educational programs and celebratory events as they are already active in a community and will know a large network of community members that may be willing to volunteer or be interested in attending. These organizations may also be helpful in sponsoring and organizing survey efforts for a historic district or larger community-based survey.

Schools, colleges and universities

Partnering with local school districts is crucial to invigorating a new generation of preservation-minded community members. Educational programs through school districts are a strategic way to pass along preservation knowledge, as well as interactive events such as historic district scavenger hunts, and outreach programs to involve a school district as well as the surrounding community.

Students may also get involved through the Preserve America Youth Summits, a program of the Conservation Legacy, that provides engaging, on-site, interactive learning experiences for students and educators which engage them in study of historic preservation, conservation, and heritage tourism issues with the primary goal of motivating them to become future stewards of historic communities, sites and land, shape policy at the local, state and national levels, and provide lasting impact on communities for generations to come. For more information on this program, visit <http://preservationyouthsummit.org>.

In addition to programs for youth, there are also a variety of historic preservation and related programs through local colleges and universities. Students have the opportunity to take courses about preservation, cultural resources, and more. At the same time, local communities can partner with these programs and students to work on reports and surveys regarding local historic resources, support interns, and a variety of other opportunities. Check with local colleges and universities to determine what academic programs are available and what opportunities already exist to create a partnership between a college and a community.

B. Policy Base of Historic Preservation

What are the foundation documents for a local preservation program? They begin with policies adopted by the elected officials in a comprehensive plan and often a more focused preservation plan as well. Specific regulations are then set forth in an ordinance and adopted rules and procedures.

Statewide preservation plan

The Power of Heritage and Place, A 2020 Action Plan to Advance Preservation in Colorado, is the state's preservation plan. The plan seeks both to stimulate professionals and organizations and inform individuals interested in saving the story of a special place or promoting an aspect of heritage, by raising consciousness about the benefits of historic preservation.

The plan outlines the current state of resources and preservation efforts statewide—including funding sources, major preservation partners, applicable legislation, and public perceptions of the state of preservation and its priorities.

Comprehensive plan

A comprehensive plan is the primary policy document for a local government. A comprehensive plan or a master plan are required for local governments that meet statutory criteria for population and growth rate as stated in CRS 30-28-106 and 31-23-206. It includes policies related to land use, transportation, and economy as well as a

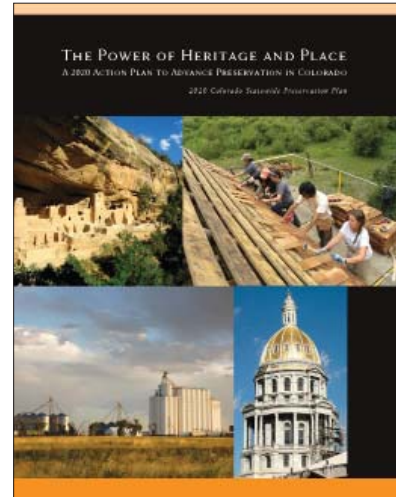

The Colorado Preservation Plan

COLORADO PRESERVATION PLAN

Refer to page 5 of the plan *The Power of Heritage and Place*, for more information on preservation goals and strategies.

<https://www.historycolorado.org/state-preservation-plan>

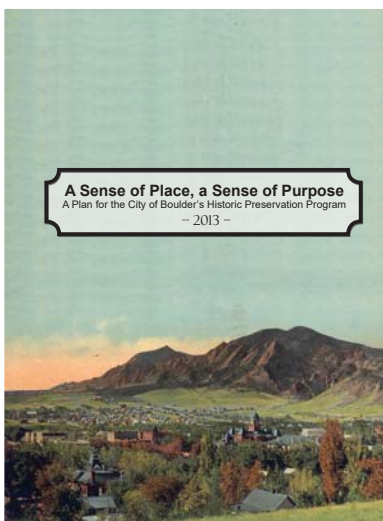
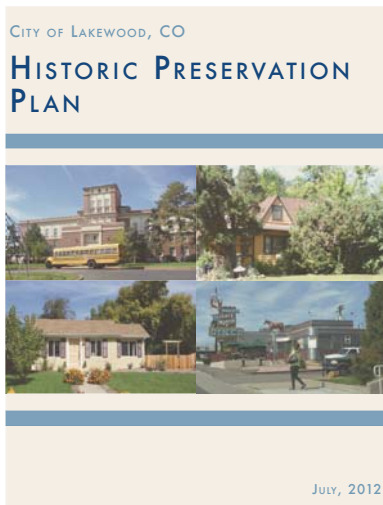

variety of other factors that address the well being of the community, including sustainability. Historic preservation is addressed in association with other land use and sustainability policies in this comprehensive plan.

Preservation element of the comprehensive plan

The comprehensive plan should contain policies and actions related to historic preservation. In some communities this may be a brief section that simply defines the role of preservation in the community, or it may be separated into its own chapter or element. The element may be extensive in detail, providing more background for the preservation program and setting forth specific actions. In other cases, however, this level of detail is presented in a separate preservation plan.

Local preservation plan

A local preservation plan provides more detail about the community's historic resources, identifies key participants, and sets forth specific action items. It should include goals for administration, management, incentives/benefits, education/advocacy, heritage tourism, and revitalization. It may also describe how other preservation partners can work with the commission to accomplish shared objectives. While local preservation plans include a lot of good information, they are, along with local sustainability policies, optional for communities.

Typical goals for developing a preservation plan are to:

- Strengthen the integration of historic preservation into the broader public policy and land-use planning and decision-making arenas at the federal, state, tribal, and local levels.
- Increase the opportunities for broad-based and diverse public participation in planning for historic and cultural resources.
- Expand knowledge and skills in historic preservation planning.
- Prepare for disaster mitigation for a community, and specifically in regards to a community's historic resources.

Preservation ordinance

A preservation ordinance is the key legal tool that establishes the commission, assigns powers and establishes basic processes for designating properties, conducting design review and engaging in other activities to which it is assigned. Preservation ordinances are among the most powerful tools available to local governments to preserve historic places and to protect community character. Counties and municipalities may designate individual buildings and districts as historic for a variety of purposes. While these properties may also be listed in or eligible for the National Register of Historic Places and the Colorado State Register of Historic Properties, local designations are made solely by the local government. (For more discussion of preservation ordinances, see Chapter 10, Legal Foundations.)

Survey plan

A Survey Plan sets forth the priorities for action related to identification and management of historic resources and for programs and initiatives for the preservation commission and its partners. This may be a stand-alone document, or it may be an element of a preservation plan. Some plans are quite brief, whereas others delve into substantial detail about the types of historic resources that may exist in the community, the issues and opportunities that relate to their preservation and the strategies for promoting preservation. They often will discuss how preservation can also support other community goals, such as sustainability, economic development and livability.

Local sustainability policies

Sustainability programs are now active across the state. While most of these focus on energy conservation and low carbon footprints, they are good places to acknowledge the role that preservation plays in meeting sustainability goals.

Main Street program and preservation policy

The Colorado Main Street Program requires that local Main Street programs follow the Main Street Approach that generally focuses on historic preservation as a base

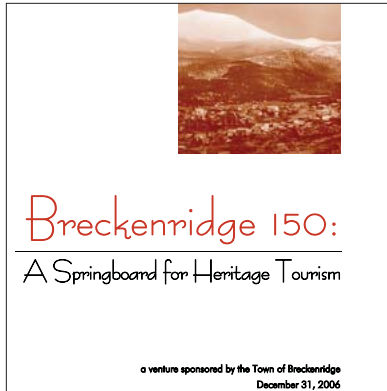

to economic development efforts. The program also requires that designated local programs have a “Historic Preservation Ethic” as defined by the National Main Street Center to include:

- The program has, or is working toward putting in place, an active and effective design management program (which may include financial incentives, design assistance, regulatory relief, design review, education, and other forms of management).
- The program encourages appropriate building renovation, restoration, and rehabilitation projects.
- When faced with a potential demolition or substantial structural alteration of a significant, historic, or traditional building in the Main Street district, the program actively works to prevent the demolition or alteration, including working with appropriate partners at the state, local, or national level to attempt to stay or alter the proposed activity; developing alternative strategies for the use of the property(s); and/or educating local leaders about the importance of retaining existing buildings and maintaining their architectural integrity.
- The program works to find creative adaptive use, financing, and physical rehabilitation solutions for preserving old buildings.
- The program recognizes the importance of planning and land use policies that support the revitalization of existing commercial centers and works toward putting planning and land use policies in place that make it as easy (if not easier) to develop property within the commercial district as it is outside the commercial district. Similarly, it ensures that financing, technical assistance, and other incentives are available to facilitate the process of attracting investment to the historic commercial district.
- The program builds public awareness for the commercial district’s historic buildings and for good design.

Heritage tourism plan

A Heritage Tourism Plan for the community will certainly rely upon historic resources and will make connections with policies for economic development, culture and livability. The plan will describe how buildings, sites and

structures can be interpreted and how residents can join in conveying to visitors the history of their area.

Some Colorado examples include:

- A Strategic Plan for Colorado Heritage Tourism Enhancement - 2006:

Available through History Colorado by request.

- City of Steamboat Springs Cultural Heritage Interpretive Plan:

<http://steamboatsprings.net/DocumentCenter/Home/View/385>

- Breckenridge, CO Heritage Tourism Strategy:

<http://www.townofbreckenridge.com/home/showdocument?id=5062>

C. Working with Boundaries

Historic districts are areas defined by specific boundaries that are drawn to include a concentration of cultural resources that are linked thematically. Understanding these boundaries is important because they often link to incentives and regulations that may influence preservation. It's also important to recognize the difference in types of historic district boundaries as well as other boundaries that may interface with a preservation program.

Local historic district boundaries

When officially designated by ordinance, a local district is usually drawn to contain a concentration of historic properties, typically termed "contributors." The district will also include properties that are considered "non-contributors." Ideally, a survey identifying contributors and non-contributors will be conducted prior to district designation. At the local level, a district may also include some blocks or parcels that create a buffer around the concentration of historic buildings, in the interest of reviewing new construction in those places to assure that the improvements are compatible with the historic resources. This may be particularly relevant when a row of historic buildings lies along one side of a street and

a row of vacant lots faces it across the street. In this respect, a local historic district boundary takes into consideration some broader community planning objectives.

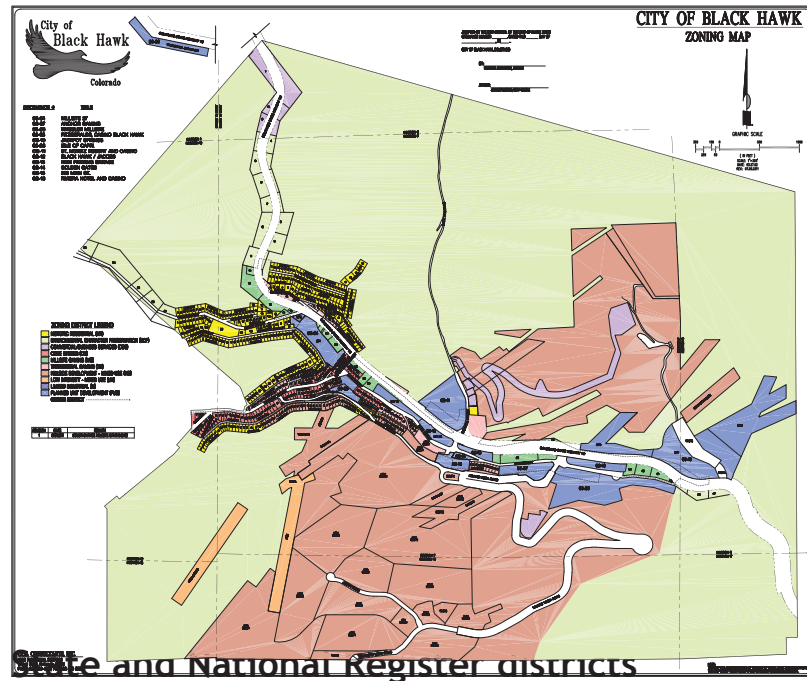

Black Hawk's zoning map identifies historic residential areas using yellow.

A district that is listed on the National Register of Historic Places or State Register of Historic Properties may be drawn a bit differently from that of a local district. These tend to focus on the concentration of historic resources. While non-contributing properties will be included, the boundary will likely not extend to flanking blocks or buffer areas.

Main Street program boundaries

All Main Street communities have a boundary within which they operate. These boundaries generally include the historic walkable downtown core and consist of a physically cohesive commercial district with a core of older, historic, traditional or architecturally significant buildings that help establish a unique, unified image. The Main Street boundary is drawn to include a range of property owners and businesses. The purpose of the

Main Street Boundary is to help focus the efforts of the local Main Street program as they work toward long range strategic plans and annual project goals. The boundary also defines the area where Main Street statistics are collected for the particular community.

The Main Street boundary is not a rigid area. As Main Street communities grow in capacity, many times their boundary may grow or expand.



In Fort Collins, the locally designated Old Town Historic district appears in a white overlay color on this aerial photo. This coincides with a portion of a National Register boundary, which is shown in a dashed black line. An abutting area, the River District, is a design overlay (shown in blue) that has a different set of design guidelines and a separate review process.

The boundary is unique to Main Street and may or may not overlap other areas such as historic districts or zoning areas. The Main Street boundary is not typically governed by these other areas unless the local program creates the link through ordinance or other locally approved manner.

Conservation districts

Some communities have a “conservation district” program, which is different from a historic district in that it may not have as many sites with historic significance. There are similar objectives, including maintaining the character of the place while accommodating compatible new construction, but these districts are not always overseen by an HPC. Zoning for a conservation district generally requires that work in the district meets certain standards for permitting, which is usually handled by staff, with appeals sometimes going to the Zoning Board or Planning Commission. On the other hand, a few communities use the term “Conservation District” to apply to an area that effectively operates as a historic district.

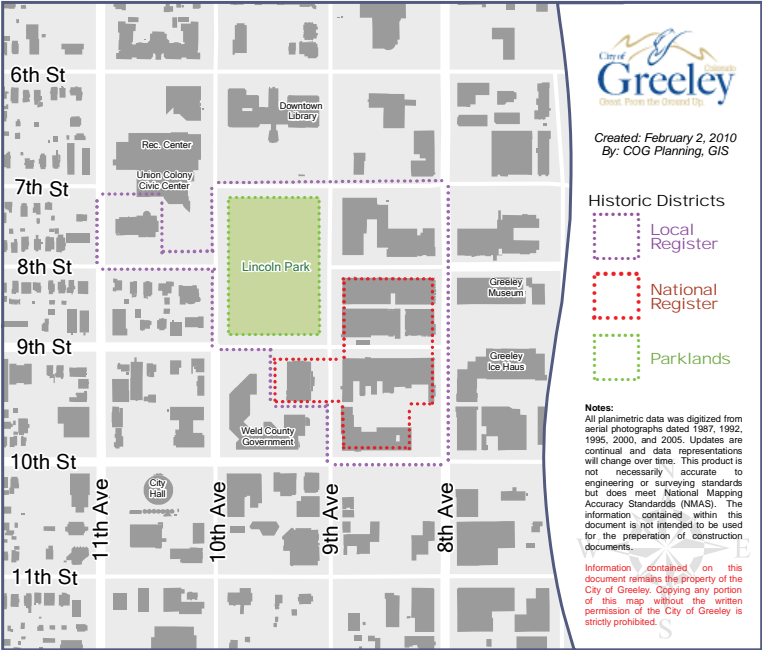

A map of the Local Historic District, National Register Historic District, and Parklands in Greeley show some overlapping boundaries of the districts.

CHAPTER 3: NUTS AND BOLTS FOR COMMISSIONS

The manner in which a preservation commission operates is founded in the roles of the commissioners and staff as they are defined in the preservation ordinance and related by-laws. It also is influenced by the criteria for designation, the guidelines for design review and other adopted procedures. This section provides guidance on the typical roles that commissions and staff have. These will vary among commissions, but many of these roles will be formally defined in the ordinance, or may be outlined in an annual work plan. Clearly understanding the roles of these players is important to conducting business in an orderly manner. It also is important that a reasoned decision-making process be followed and formally recorded. This chapter addresses some of these “nuts and bolts” of commission operations.



In This Chapter:

- A. The HPC and Its Staff
- B. Defensible Decision-Making
- C. Requirements for Continued Certification as a Certified Local Government

NATIONAL ALLIANCE OF PRESERVATION COMMISSIONS CODE OF ETHICS FOR COMMISSIONERS AND STAFF:

For more discussion about appropriate behavior for commissions and staff, see:

National Alliance of Preservation Commissions Code of Ethics for Commissioners and Staff

Available through the National Alliance of Preservation Commissions.

www.napcommission.org



A. The HPC and Its Staff

What is a Historic Preservation Commission?

It is an appointed body, established by the governing body (usually a City Council or County Board of Commissioners). Its powers are those delegated to it by the governing body.

Appointment to the commission

Commissioners are usually appointed by the elected body of the local government, such as a city council or board of county commissioners. Some jurisdictions may provide for appointment by the mayor.

Qualification of members

Those to be appointed to a preservation commission should have a demonstrated special interest in the field. In addition, the ordinance may specify requirements related to certain professional fields associated with design, history and other relevant topics.

For those jurisdictions that are Certified Local Governments, at least 40% must meet the Secretary of the Interior's Professional Qualification Guidelines, which provide guidelines for professional experience in a variety of categories. https://www.nps.gov/history/local-law/arch_stnds_9.htm

HPC roles

Citizens provide a public service to their communities by serving on preservation commissions. As such they help to promote implementation of the community's adopted policies and regulations related to historic preservation. They should do so objectively, without introducing their personal biases.

This is because commissions serve as an arm of local government. This role is to be distinguished from a local non-profit organization, such as a historical society or preservation advocacy group. These other organizations are private entities, and may engage in advocacy or in promoting new policies.

The primary responsibility of a commissioner is to serve the public interest by identifying and protecting historic resources that have been determined to be important to the historic or architectural character of the community. Most ordinances further define a range of powers and responsibilities for the commission. These are typically:

Preservation Plans

Commissions may engage in long-range planning activities in their communities to assure that historic preservation is an integral part of public policy, and they also sponsor planning for treatment strategies of individual historic properties.

Identification

Commissions sponsor surveys that catalogue properties and serve as a basis for identifying resources with historic significance.

Evaluation

Commissions also work to evaluate the potential significance of properties identified in surveys, using adopted procedures and criteria.

Stewardship

Commissions promote proper use and care of historic properties. They do so by reviewing proposed improvements, discouraging demolition and encouraging use of incentives to facilitate preservation.

Reviewing projects and advising

Commissions review proposed changes to the exteriors of properties within designated historic districts, and assist property owners in devising appropriate strategies for maintenance and improvements. (Note that this assistance is provided in the context of public meetings, not one-on-one consultations.)

Monitoring and site visits

Commissions observe work in progress, and visit sites prior to decision-making. Note that site visits may be subject to open meeting laws.

RELATIONSHIP TO MAIN STREET PROGRAMS:

Many of these roles also relate to other organizations that include historic preservation in their objectives. Each local Main Street program uses long-term strategic goals and annual work plans to build capacity and guide revitalization of their area. The majority of items such as surveying historic properties, stewardship, incentives, partnerships and education are commonly found within an annual or strategic plan of the local Main Street organization. A partnership between a historic commission and a Main Street program can result in better use of resources and help build the capacity of the community to move initiatives forward.





Decision-making

Commissions review design proposals, approve Certificates of Appropriateness and also recommend designation of properties as historic resources.

National Register nominations

Commissions may work to officially designate properties to the National Register that meet eligibility requirements. They do so by nominating those properties to the SHPO (History Colorado) for formal listing. CLGs are required to provide comment to the SHPO on all National Register nominations for properties in their jurisdiction.

Administering incentives

Commissions approve applications for local incentives, such as property tax credits and sales tax rebates. CLGs also have the option to elect to review all Colorado Historic Tax Credit applications for residential properties within their jurisdiction in lieu of the application being submitted to the SHPO (History Colorado).

Education

Commissions promote awareness and appreciation of historic resources and preservation programs, as well as appropriate treatment through technical procedures, education and design.

Providence, RI advertisement to encourage walking throughout the community, created by the Rhode Island Prevention Coalition.

Path to Health

Path to Health is a simple way to help people enjoy a pleasant walk. The paths are marked at 1/2 mile intervals by signs. You can start anywhere on a path and learn what you have accomplished.

Walking is a simple, safe, and enjoyable way to get 30 minutes of activity most days of each week.

Take a friend and ENJOY your Path to Health.

Let's Go Walking... on the Path to Health

"America's renaissance city welcomes you to the first Path to Health in the nation. Get moving, have fun, and stay healthy. Let's go walking!"

-Vincent A. Cianci, Jr., Mayor, City of Providence

Downtown Providence Path to Health

At historic City Hall and the Fleet Skating Center you have three path choices. One loop visits Waterplace Park, the Providence Place Mall, the magnificent Capitol, Roger Williams Park, and the RISD Museum. Another loop takes walkers down Historic Aynbois Street near the Civic and Convention Centers, past Johnson and Wales University to the wonderful Children's Museum. Passing Davol Square, crossing the Providence River, the Path progresses along Benefit Street with its many lovely houses and schools. The third loop leaves the Children's Museum and takes one around the Lifespan Women's and Infant's Hospital complex.

Historic Armory - Broadway District Providence Path to Health

This path passes historically important features of Rhode Island's capital city. From the Brigham School, the path proceeds on Broadway past many historic buildings and lovely shops to Dean Street. Following Dean Street leads to Westminster Street, past Classical and Central High Schools to Dexter Street and the lovely Armory Park. The Armory itself is an historic monument of architectural significance. Turning on Cranston leads the walker to Chapin and then Messier Streets to complete this Path to Health.

American Heart Association, Rhode Island State Police, Lifespan

Facilitation

Commissions help property owners find skilled craftsmen and materials suppliers as well as assist them in obtaining other permits that will make rehabilitation possible.

Partnerships

Commissions also engage in partnerships with other groups and individuals. These include local non-profit organizations whose purpose is to promote preservation as well as others that recognize the value of preservation in meeting their own core missions.

Promotion

Commissions also engage in promoting preservation through special events, awards and media channels. The Main Street Four Point Approach, which is an economic development tool for local initiatives to revitalize their historic districts by leveraging local assets, recognizes promotion as one of the four major components to building a sustainable and complete community revitalization effort. This approach recognizes that promotion takes many forms, but the overall goal is to create a positive image that will renew community pride and will tell your Main Street story to the surrounding region.

Section 106 Comments

The Section 106 Review process is an important part of the National Historic Preservation Act of 1966 because

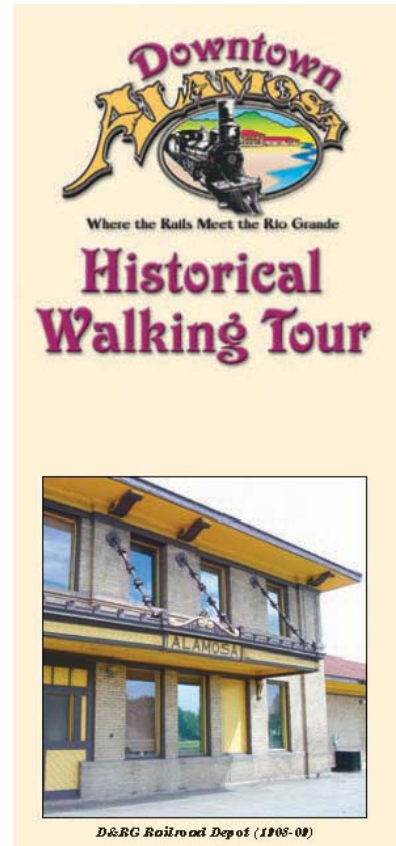

Brochure for a historic walking tour of Downtown Alamosa, a strategy for promoting the historic district and local tourism.

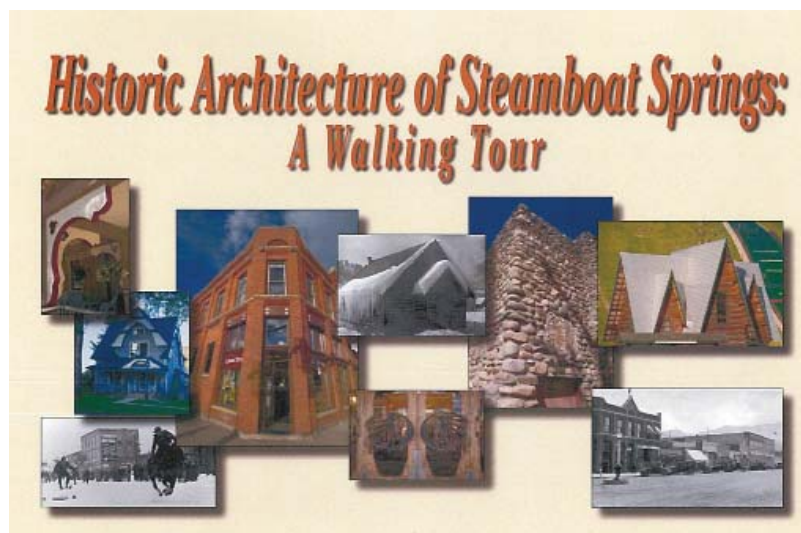

Brochure cover for a walking tour focusing on historic architecture in Steamboat Springs.

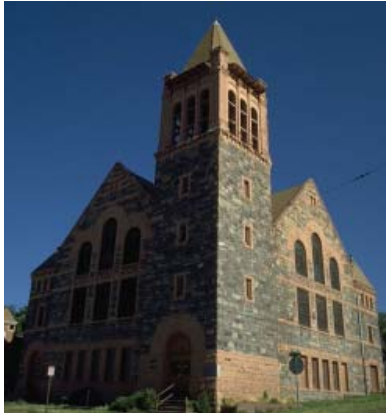

it requires consideration of historic preservation in projects with federal involvement. This requires federal agencies to consider effects of projects they carry out, approve or fund on historic properties, and encourages, but does not mandate, preservation. A commission may be a consulting party to a Section 106 review. For more information regarding the Section 106 review process, please see Chapter 8.

Staff roles

Many commissions have staff assigned to assist in their operations. Some typical roles:

As technical advisors to property owners

For communities with professional preservation staff, they may provide technical assistance related to appropriate treatment of properties, design and planning considerations. This may occur in the form of staff reports, with recommendations to the commission, and may also include informal guidance to property owners.

As administrators to the commission

This includes general clerical responsibility, such as publishing notices of hearings and agendas, and record keeping.

As decision-makers (when delegated)

Some ordinances provide for administrative decision-making, usually for specific types of work. These may be for minor alterations, and when locally adopted guidelines are clear.

Operating without staff

Although not a role as those listed above, some commissions may find themselves in the situation of having no staff or administrative support. Others may only have part-time assistance of a town clerk or building official. In these cases, commissioners often take on some of the administrative responsibilities. They may rotate this position to different board members to distribute the burden of these added tasks. This may include handling the applications for a Certificate of Appropriateness to assure that they are complete, posting meeting notices and recording the meeting minutes.

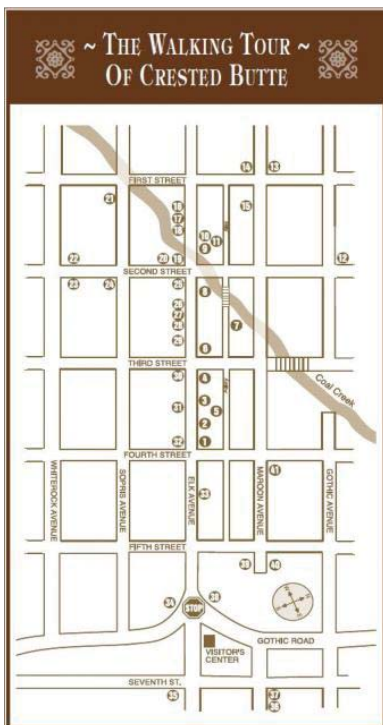

Meeting operations

Conducting effective meetings is an essential part of operations for a preservation commission. This also applies to Main Street Boards and other organizations that may operate in areas with historic resources. These are some basic principles for effective meeting management:

Meeting agendas

An essential tool is the meeting agenda. It should follow a standard format, which may be established by the local governing body for all of its commissions. It should be published in advance of the meeting, and provide enough information for interested parties to know when and where the meeting will occur, what topics will be discussed, and the types of actions that may happen.

1. Call to Order (includes a role call and confirmation that a quorum is present)
2. Special Administrative Actions (if needed; may include new appointments to the commission or seating of an alternate commissioner; may also include changes to the agenda, if needed)
3. Approval of minutes from the previous meeting (with amendments if necessary)
4. Public Participation for items not on the agenda (usually time limited)
5. Staff reports of administrative decisions (if the ordinance provides for this)
6. Consideration of old business (such as final actions on previous agenda items)
7. Public Hearings for designation and design review (taken in the order published, unless an adjustment is necessary)
8. Other Matters (such as reports from other boards or commissions, discussion of on-going projects and assignments)
9. Scheduling (confirmation of next meeting date, upcoming site visits, etc.)
10. Adjournment

Posting notices

Another essential tool is the meeting notice, which must be published in advance of a formal commission meeting. Local government rules will establish the requirement

Brighton Historic Preservation Commission
Historic City Hall, 22 S. 4th Ave., 3rd Floor, Heritage Room
Brighton, CO 80601

Agenda
Date: June 9, 2016
6:00 p.m.



BRIGHTON HISTORIC PRESERVATION COMMISSION
909 S. 4th Avenue
Brighton, CO 80601
303.455.5242
www.brightonco.gov/bhpc

Chairperson:
Allison Lockwood

Vice-Chair:
Danielle Henninger

Administrative Director:
Joseph Burt

Commissioners:
Cheri Lopez
Lynette Marrs
Patricia Reither

City Council:
Betsy Peterson
Ken Krueger
J.W. Edwards - Alternate

Members:
Wayne Scott

Youth Commission:
Bianca Williams

Advisors:
Andy Peterson

City Admin. Assistant:
Sheryl Johnson

City Staff:
AJM TBMS

I. CALL TO ORDER / PLEDGE OF ALLEGIANCE	Allison Lockwood
II. ROLL CALL	Sheryl Johnson
III. SWEARING IN OF JODIE PETERSEN	Natalie Hoel
IV. SEATING OF ALTERNATES	Allison Lockwood
V. APPROVAL OF AGENDA	Allison Lockwood
VI. APPROVAL OF MINUTES FOR MAY 12, 2016	Allison Lockwood
VII. CONSENT AGENDA	Allison Lockwood
No Items Submitted	
VIII. PUBLIC COMMENT	
Public invited to be heard on matters not on the agenda (Limited to 5 minutes)	
IX. REPORTS / PRESENTATIONS	
Committees:	
Historic Properties Committee	Gary Wardle
Bronley / Historic Parks Update	Wayne Scott
Downtown Historic District Update	Robin King
Great Western Sugar Company Update	Allison Lockwood
Watch List - 728 S. Main Street	
Staff:	
No Report	
X. UNFINISHED BUSINESS	
2016 Finances	
XI. NEW BUSINESS	
XII. ADDITIONAL COMMENTS	
Downtown Mutual Project	Allison Lockwood
Commission Update	Allison Lockwood
XIII. ADJOURNMENT	
XIV. ANNOUNCEMENTS	
Community BBQ - July 21, 2016	
Market Day - August 20, 2016	
Eco Fair - September 24, 2016	
Historic Preservation Gala - November 12, 2016	
Winter Fest - December 10, 2016	
NEXT MEETING JULY 14, 2016	



APPLYING MEETING PROCEDURES FOR PARTNER ORGANIZATIONS:

This advice for orderly operations of meetings is also applicable to Main Street Program Boards and other organizations who may support preservation initiatives.

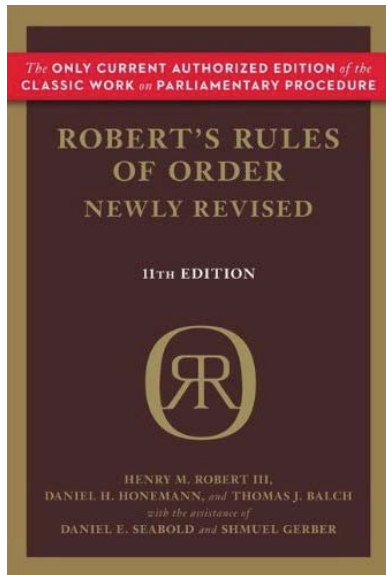

MEETING MINUTES
CARBONDALE HISTORIC PRESERVATION COMMISSION
Thursday September 3, 2015

CALL TO ORDER:

ROLL CALL:

Ramsey called the meeting to order at 6:38 p.m.

Present:

Ramsey Fulton
Michael Durant
Carol Klein
Ashley Allis
Dorothea Farris

Lisa Nieslanik, Boards and Commissions Clerk
John Leybourne, Town Liaison

Absent:

Dana Ellis

CONSENT AGENDA:

Tatanka Consulting Services:

Ramsey stated why he thought it was a good idea to have Ron with Tatanka write the grant.

for how many days in advance the meeting notice must be posted and how. In many cases, a meeting notice will be published online but also may be published in a local newspaper. Often, a sign also must be posted at the site of a property that will be on the agenda of an upcoming meeting.

Robert's Rules of Order

An essential guide to proper management of a public meeting is the book *Robert's Rules of Order*. Originally published in 1876 and regularly updated, it sets forth the basic principles of parliamentary procedure. It covers many actions that are often addressed in a commission's by-laws and also includes good advice on how to assure that all parties are heard in an orderly manner. If a commission does not have a separate set of rules and procedures, this book can serve that purpose and should form the basis of meeting operations. The National Alliance of Preservation Commissions also publishes a document that summarizes the basic principles, titled *For the Record: The NAPC Short Guide to Parliamentary Procedure* (<https://napcommissions.org/wp-content/uploads/04-For-the-Record.pdf>).

Public participation

The rules of procedure should establish the way in which the public may participate in the commission's meeting. There are typically two ways: First, a citizen may speak during a time that is designated on the agenda for general comments that do not relate to items on the published agenda. For example, one may bring a matter to the attention of the board suggesting that a historic survey be conducted for a particular neighborhood, or to raise a question about future plans for treatment of a local landmark. The second method of participation is during the Public Hearing phase on the agenda. This is when individual items are considered, and there is a designated step at which point members of the public may speak to the item.

Meeting minutes

Keeping a clear record of each meeting is essential. This should include a summary of all discussions as well as the decisions that are made. It need not be extensive in detail, but should be sufficient to portray the nature of the item that was discussed, the issues involved, and the findings and actions that the board took. In many cases, an audio recording may provide an added level of detail.

B. Defensible Decision-Making

Defensible decision-making is simply the act of following all steps required to ensure due process. It is essential that the commission's decisions be seen as fair and objective and based on facts and established criteria and guidelines. The commission's decision must be accurately documented such that, in the future, the process and the reasoning for the decision are clear.

Commissioners should NOT make decisions based on:

- Personal taste. Use the guidelines instead.
- Opinions of the applicant. Focus on the project, not the person.
- Information that is not in the public record.

The basic principles for defensible decision-making apply to all commission actions, which may include applying criteria for historic significance, conducting design review, or considering applications for economic hardship. In each case the reasons for making the decision and the information that was used should be recorded.

MORE HELP:

The National Park Service provides a document with an introduction to basic legal concepts and issues they may encounter as preservation commissioners. This document is titled:

LAW AND THE HISTORIC PRESERVATION COMMISSION: WHAT EVERY MEMBER NEEDS TO KNOW

<http://napcommissions.org/wp-content/uploads/2013/08/01-Law-and-the-HPC.pdf>



Some key questions:

What are the elements of a defensible decision?

The decision should be based on the relevant ordinances, rules and procedures, including the formal survey and designation information and the adopted design review criteria and guidelines. It should be clearly stated, avoiding “double negatives” or unclear directives.

What should a motion say?

A motion to decide on a proposal should include:

- The stated action -- approve, deny, etc. (See Chapter 6)
- The name and address of the property
- The “title” of the work proposed--alteration, addition, etc.
- Statement of compliance (or lack of). Be sure to reference the criteria/guidelines on which the decision is to be made
- Reference the significance of the property and its character-defining features, as described in survey documents
- Reference the submittal documents

If the action is to approve a design proposal, an important consideration is that the motion and the conditions of approval are clear enough that, should it become necessary, non-compliance or a violation of the Certificate of Appropriateness can be proven. Many commissions have a “motion cheat sheet” to help commissioners remember to include all the elements above into a motion.

What should the minutes include?

Minutes should describe the items on the agenda as they occurred, with an indication of the actions taken, and references to the documents that were considered in the actions. Keep in mind that this may be the first point of reference that someone goes to for future research, and it should provide a “link” to other information that may be on file.

What should the administrative record contain?

Each project “case” should contain:

- Application form
- Supporting documentation describing the property and proposed action

- Hearing notice
- Minutes of the hearing
- Formal written letter of the decision and a copy of the Certificate of Appropriateness
- Any other documents submitted that were a part of the hearing (e.g., letters from interested parties, professional reports)

Remember: should a decision be appealed, the appellate body typically will only consider the information in the record, not new information. In this type of appeal, the focus is on the process by which the commission made its decision in terms of following due process and applying guidelines uniformly. In some cases, however, the law provides that the appeal is to be heard anew, or “de novo,” with new information being permitted to be considered.

What are the basic legal considerations to address?

The decision must be made with these considerations:

- Compliance with open meetings regulations
- Following Procedural and Substantive Due Process
- Disclosing any ex parte communication
- Addressing any conflicts of interest
- Maintenance of a complete record

How are appeals handled?

In many communities an appeal goes first to the elected official governing body, such as a City Council. Further appeals may then go to the courts. Other governments, however, provide that an appeal goes directly to the court of jurisdiction. Applicants always have the right to appeal, and in some communities other citizens may also have “standing” to appeal a decision.

C. Requirements for Continued Certification as a Certified Local Government

After certification as a CLG, a community must continue to uphold a set of requirements in order to maintain their certification. The SHPO (History Colorado) is in charge of monitoring and evaluating the performance of the CLG. More information can be found in the Colorado Certified



MORE ABOUT CLGS:

These requirements for a community to maintain its CLG status help uphold the CLG goals which include:

- Historic preservation issues should be understood and addressed at the local level and integrated into local planning
- Local governments should develop local preservation efforts that contribute toward and benefit from state and federal programs
- Participation by local governments should enable federal and state governments to recognize and support local preservation efforts
- Participation by local governments should result in an increase in awareness within the community of local preservation issues, programs, policies, and procedures

Local Government Handbook: <https://www.historycolorado.org/sites/default/files/media/document/2017/1416.pdf>

Requirements for continued certification include:

- Maintain a qualified ordinance and Historic Preservation Commission (with at least 40% of members meeting the Secretary of the Interior’s Standards for Treatment of Historic Properties for professional qualifications)
- Meet at least four times per year
- Maintain a system of survey and inventory
- Enforce the local preservation ordinance
- Ensure that all design standards and decisions are based on the Secretary of the Interior’s Standards for Treatment of Historic Properties
- Provide public access to minutes, designation files and survey forms
- Submit meeting minutes to the SHPO at the same time they are distributed to the Commission
- Attend an educational session workshop each year (at least one commission member)
- Comment on National Register of Historic Places nominations in their community
- Submit a comprehensive report to the SHPO annually

CHAPTER 4: IDENTIFICATION OF HISTORIC RESOURCES

How is it determined that a property has historic significance? Professionals in the fields of history, historic preservation and historic architecture work with staff, commission members and advocates to evaluate properties, using adopted standards that are recognized nationally. They employ a variety of research tools to assist them in making those determinations.

Research tools include summaries of historic patterns, defined as “contexts” and “themes,” along with descriptions of the typical property types and building styles associated with them. Geographic Information Systems have also emerged as important tools for identifying potentially significant resources.

The most familiar tool related to identification of cultural resources is the survey, in which individual properties and districts are assessed for their potential historic significance. In order to place that evaluation into a broader understanding of history, communities also use historic overviews, called “contexts” that describe various themes in community development that may help in evaluating significance. At an even broader level, a Preservation Plan may set priorities for surveying. Those properties found to have historic significance may then be entered into a Historic Resource Inventory. Each of these tools is described briefly in this chapter.

In This Chapter:

- A. The Preservation Plan
- B. The Survey Plan
- C. Historic Context Statements
- D. Surveys
- E. Inventories

OBJECTIVE CRITERIA:

Recognition of historic resources from early settlement to the more recent past continues to change and grow. Communities use a variety of tools to organize and define resources.

Historic Property Types

Groups of properties with common physical attributes or that share relationships with historic figures and events may be considered distinct historic resource types. In many cases, historic resource types are associated with particular historic contexts or periods in history.

Landmarks and Districts

Many historic resources are officially recognized in the national, state or local historic registers. Additional historic resources exist but have not yet been identified or formally listed. Historic listing provides opportunities for specific preservation incentives and may provide specific protections for listed properties.



CITY OF LAKEWOOD, CO

HISTORIC PRESERVATION PLAN



July, 2012

Town of Georgetown, CO

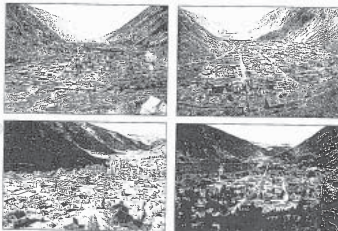

Preservation Plan

A. The Preservation Plan

The Preservation Plan establishes a comprehensive program for historic resources for a community and outlines ways in which preservation can be integrated into many other aspects of the community including housing, sustainability, livability and economic development. While every preservation plan is different, many of the elements are the same, covering topics regarding evaluation of current historical resources, management tools, and potential outreach strategies.

The plan generally begins by outlining the history of the community and the role preservation has had and currently has within the structure of the community. This section may also discuss important historic resources to the community, and historic property types, trends, and themes that can be seen through the resources. Next, the plan will typically outline recommended program components, including administration, identification, management tools, incentives and benefits, education, advocacy and partnerships, and heritage tourism. From there, program goals, policies and actions will be identified, with priority levels. Finally, the plan will conclude with implementation strategies that will include phasing criteria and other ways in which the plan can be integrated into existing structures as well as ways in which businesses, property owners and community members



can use the plan to learn about the program and status of local preservation efforts.

B. The Survey Plan

The implementation strategy of the survey plan should set priorities for surveying in the community. This may be based on an analysis of data about property age and condition, as well as previous historical research. The plan should describe any existing surveys that are on record, their age and adequacy in terms of whether any updates are needed. A search of History Colorado's COMPASS database will provide a list of all surveys in a particular jurisdiction on file with the SHPO. The plan also should consider the status of any historic contexts that exist or that are under development as a precursor to survey work. Priorities may be influenced by a goal to address resources associated with particular themes, under threat, or socio-economic or geographic elements in the community.

Other external events may also influence how priorities for surveying are set; for example, an impending street improvement project may prompt the need to survey abutting properties to determine if any potential impacts to historic resources would occur.

C. Historic Context Statements

A "Historic context" groups information related to existing historic resources based on a subject, specific time period or geographic area. The relative importance of historic resources is better understood by determining how they fit into a theme. A historic context provides an essential basis for determining the association that a property may have in the history of the community and, therefore, is a key tool used to identify resources with historic significance.

Historic contexts discuss the patterns and trends that produced individual properties and areas of development in a community. Other terms are frequently used, such as trend or pattern, but the concept is the same. The

COMPASS DATABASE:

COMPASS is an online database run by History Colorado that is designed for archaeologists, historians, students, researchers, planners and anyone interested in learning about Colorado's cultural resources. It contains documentation on archaeological sites, historic buildings, bridges, cultural landscapes, churches, houses, rail cars, and more. CLGs can take advantage of free access to this incredible database, which can be found at <https://www.historycolorado.org/compass>.

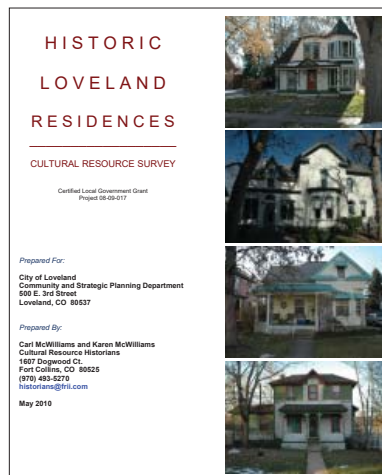



A Place Set Apart: The History and Architecture of Pueblo's East Side Neighborhood

Prepared by:

Jeffrey DeHerrera
Adam Thomas
HISTORITECTURE, L.L.C.

Prepared for:

City of Pueblo, Colorado
Certified Local Government Grant
Project CO-08-013

July 2009



HISTORITECTURE LLC
architectural history | preservation planning | digital preservation-media

SURVEY DATABASE SOURCES

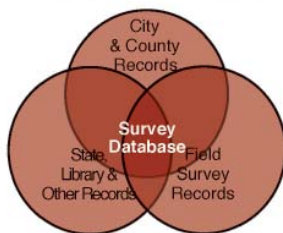

core premise is that properties represent interweaving factors in history and did not develop in isolation. These relationships are understood in the context descriptions.

A historic context includes three elements: a historic theme, geographical area, and a chronological period. Themes are often used to organize a historic context. For example, the theme of transportation may address a variety of methods of moving people and goods during different periods in the history of the city. In other cases, a geographic approach may be used.

D. Surveys

Historic resource surveys collect information about the history and condition of properties community-wide or in selected areas. They use adopted criteria for determining which properties or districts have historic or archaeological significance and integrity. Surveys can be undertaken for a variety of purposes and should be tailored to meet specific needs and goals. When planning a survey project, CLG communities can consult History Colorado staff for assistance in developing an appropriate scope of work and methodology that will efficiently and effectively meet goals and needs. Consulting History Colorado staff is also an important step when a CLG community is seeking CLG or State Historical Fund survey grants. Finally, consulting with History Colorado prior to beginning a survey project is also recommended as the information that follows in this guide is very general and may not be applicable to all survey projects.

The survey process includes a field inspection, collecting historic information about the physical and cultural history of the property and documenting it in photographs, drawings and maps. A survey report typically includes a listing of all of the properties researched, indicating the significance and integrity of each of the resources and, where applicable, should also include a description of the general character of the district. Additionally, the survey should include a definition of key characteristics of individual properties as well as the defining characteristics of groups of buildings or neighborhoods.



It is important to note that there are a variety of types of historic resource surveys, each of which is completed for a different purpose. The first distinction to make is that of reconnaissance versus intensive surveys. History Colorado provides survey forms that should be used for both reconnaissance surveys (Form 1417) and intensive surveys (Form 1403).

A reconnaissance survey is most appropriately used when gathering data to refine a developed historic context and to define specific property types in a particular area. This type of survey is a visual or predictive survey and only provides a general understanding of the historic properties in an area, their general condition and integrity, and resulting implications for future land use planning. A reconnaissance survey should document the types of properties looked for, the boundaries of the area surveyed, the method of the survey, the kinds of historic properties present in the surveyed area, specific properties that were identified, and places examined that did not contain historic properties.

While a reconnaissance survey provides valuable information about historic properties in an area, an intensive survey would need to be conducted to determine more exact information about historic properties in an area, which helps when making treatment decisions for a historic property, for example. An intensive survey should document and describe the distribution of properties in an area, the boundaries of the area, the number, location, condition, and types of properties in the area, the physical extent of the specific properties, reported item, the method of survey, and information on the appearance, significance, integrity, and boundaries of

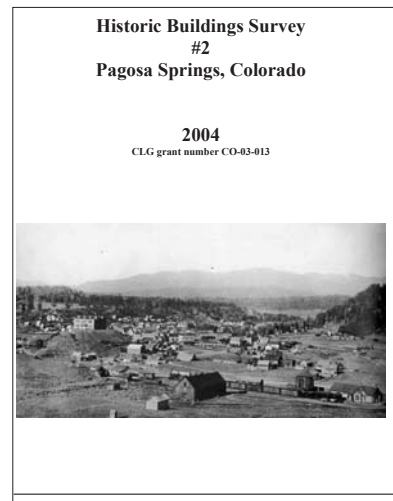
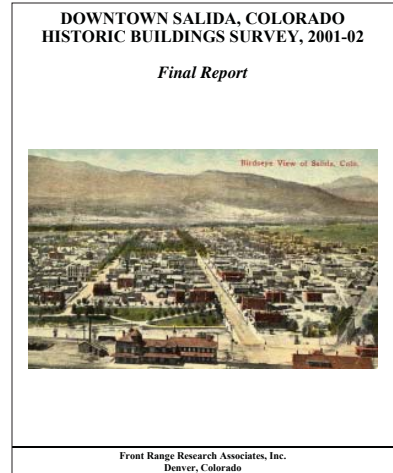

COLORADO CULTURAL RESOURCE SURVEY MANUAL

The Colorado Office of Archaeology and Historic Preservation has published a manual that provides guidance for conducting cultural resource surveys in Colorado. This document can be found at:

<https://www.history-colorado.org/sites/default/files/media/document/2017/1527.pdf>

SAMPLE SURVEY AND INVENTORY FORMS

For more information regarding survey and inventory forms, History Colorado provides forms based on project type at:

<https://www.historycolorado.org/survey-inventory-forms>

<p>200 W Colorado Ave SSM1554</p> <p style="text-align: center;">COLORADO CULTURAL RESOURCE SURVEY</p> <p style="text-align: center;">Architectural Inventory Form</p> <p style="text-align: center;">Page 1 of 8</p>	<p>Official Eligibility Determination (OAHHP use only) OAHHP1403 Rev. 9/98</p> <p>Date _____ Initials _____</p> <p><input type="checkbox"/> Determined Eligible – National Register</p> <p><input type="checkbox"/> Determined Not Eligible – National Register</p> <p><input type="checkbox"/> Determined Eligible – State Register</p> <p><input type="checkbox"/> Determine Not Eligible – State Register</p> <p><input type="checkbox"/> Need Data</p> <p><input type="checkbox"/> Contributes to eligible National Register District</p> <p><input type="checkbox"/> Noncontributing to eligible National Register District</p>
--	---

I. IDENTIFICATION

1. Resource number:	SSM.1554	Parcel number(s):	477901121042
2. Temporary resource number:	N/A		
3. County:	San Miguel		
4. City:	Telluride		
5. Historic Building Name:	San Juan Hardware Company ; Tomkins Hardware Company; Tomkins-Cristy Hardware Company		
6. Current Building Name:	Patagonia Sportswear		
7. Building Address:	200 W. Colorado Avenue		
8. Owner Name and Address:	Molen 209 LLC P. O. Box 832 Telluride, CO 81435		



THLD RATING:	Contributing to District
---------------------	--------------------------

Cultural Resource Historians • 1607 Dogwood Court
Fort Collins, CO 80525

each property. An intensive survey should determine significance and integrity of a set of historic resources and therefore should provide eligibility of the property for the various Registers.

The additional types of surveys to distinguish are those of selective and comprehensive surveys. A selective survey looks at specified sites while a comprehensive survey looks at all sites in a geographic area or all sites of a certain type or period in a geographic area.

The Colorado Main Street program encourages the use of surveys and inventories for downtowns. These can help build awareness of historic properties as assets in creating

a distinctive sense of place and in planning for heritage tourism initiatives. This information also can be used in design assistance and rehabilitation loan programs.

For archaeological surveys, fieldwork is commonly required to assess significance. In many cases this involves the placement of hand-excavated probes to analyze site stratigraphy and identify any artifacts and subsurface deposits. The final product of any cultural resource study is a full and detailed report documenting the methods and results of the survey.

New survey techniques

New technologies now allow data gathering and evaluation to occur more efficiently. An important innovation is linking survey data through a Geographic Information System (GIS). Combining historical records and building permit information in GIS improves recording and access to a wide range of property information.

Additional data may also be gathered by allowing property owners to upload information about their properties to a government web site. When combined, these new technologies can support ongoing survey efforts that ensure up-to-date documentation of a community's historic resources.

Some communities are also using a tiered survey system that is based on the level of integrity and significance of the historic resources. Such a survey may also identify



DENVER HISTORIC SURVEY CITYWIDE SURVEY STRATEGY

Denver's urban fabric is enriched with structures, sites and places that convey its history and building traditions. These assets contribute to the livability and economic well-being of the city while supporting sustainability objectives.

The following statement from Denver's Comprehensive Plan 2000 clearly articulates the community's commitment to preservation:

"Denver's highly livable urban environment will be preserved and enhanced through policies that support the ongoing development and maintenance of the parks and parkways system, preserve historic resources, and require quality urban design consistent with Denver's traditional character." (page 55 of Denver Comprehensive Plan 2000).

To honor this commitment and meet state requirements for Certified Local Governments (see Certified Local Government Status on page 4 for more information), the community must have a means of identifying and building awareness of its cultural resources. In response, Historic Denver, Inc., in partnership with the City and County of Denver, has developed a strategy to guide a citywide historic survey effort. The strategy provides a blueprint for a survey program that supports city planning efforts, assists owners in understanding their properties and provides educational opportunities to the public.

This report describes the citywide survey strategy for Denver. The strategy builds on a foundation that includes an evaluation of local conditions and projects completed or underway in peer communities. See Appendix A: Existing Conditions in Denver and Appendix B: Historic Surveys in Peer Communities for more information.

Preliminary steps for the historic survey will begin in the Summer of 2011. The full citywide survey is expected to be underway by the Fall of 2013. See Chart 1: Survey Phases and Draft Schedule on page 6 for more information.



IN THIS REPORT

Survey Background.....	3
Project Objectives.....	4
The Overall Survey Approach and Scope.....	5
Primary Survey Tools.....	7
Community Involvement.....	18
Survey Phases.....	20
Survey Pace.....	23

OCTOBER 6, 2011





new buildings that are compatible with their context. A tiered survey can be linked to a variety of planning objectives, or be calibrated to fit differing benefits and incentives, or review and permitting processes. For example, properties with a high level of historic significance may be subject to review by the Preservation Commission, whereas those of a lesser level may be handled by staff.



Discover Denver is one such example of a new survey technique. Led by Historic Denver, Inc. with the City and County of Denver and History Colorado as partners, this survey gathers information using public records, neighborhood canvassing, academic research, and tips from the public. While there are partner organizations spearheading this initiative, the surveying itself is completed primarily by the Discover Denver Volunteer Corps, which is made up of students, professionals, retirees, and any interested Denver residents. The survey is completely accessible online so that everyone has the opportunity to learn about Denver's past through information on individual buildings.

Resource identification and the GIS

In recent years, the Geographic Information System (GIS) has emerged as an important tool in developing an understanding of where historic resources may be located and how they relate to other planning factors, including land use, transportation patterns and socioeconomics. The GIS system contains many "layers" of information linked to individual properties in a community. It is widely used in many governmental departments and thus offers the capability of combining information from individual disciplines, including preservation, with other community programs. The survey of historic resources compiled by Central City, as a response to their designation as a CLG, provides a great example for utilizing GIS to map survey results. After conducting field surveys, GIS was used to map 243 contributing resources in the Central City-Black Hawk Historic District, and 79 non-contributing resources.



OLD TOWN STEAMBOAT SPRINGS INVENTORY AREA

E. Inventories

What is an inventory?

An inventory is a collection of data about the potential historic significance of properties in a community. It includes any surveys of historic resources, as well as individual evaluations of properties that may be conducted for a variety of research purposes. It is maintained as an informational source. The inventory usually includes the evaluation of resources for potential eligibility for listing in a formal register of historic resources, but the inventory itself does not bring with it any regulatory requirements.

How is an inventory used at the local level?

At the local level, a preservation commission uses the inventory as a reference point in determining if any properties would merit consideration for designation. They also use the inventory as a means of developing educational materials about the historic resources of

the community or for background information during project review.

Planning departments may also use this information when developing neighborhood plans, or when evaluating development proposals that may require special review under development permitting regulations other than the preservation ordinance.

Main Street programs collect building and business inventory information to help inform larger economic and revitalization strategies. The inventory work will help inform where to target incentives, and what type of incentives are available or applicable to the specific projects. The information collected through the inventory also allows the local Main Street program to help promote the historic assets, organize educational initiatives and support rehabilitation projects within the community.

Why is it important to keep an inventory up to date?

Since the historic resource inventory is the starting point for research, education programs, and nominations, its value is greatest when the information is up to date. The status of a property as having potential historic significance can change due to a loss of integrity, or new interpretations of historic significance in the community, and thus regular updates of surveys is important. Increasingly, local governments are integrating survey information into Geographic Information Systems, which means that this information can now be updated more efficiently.

CHAPTER 5: DESIGNATING PROPERTIES

Designating a property means formally listing it under local law as a historic resource or as part of a district. This action requires formal hearings. It also requires an appropriate level of documentation that substantiates the historic significance of the property. This includes information from a survey, using specific categories for classifying properties, information that places the property into historical context, and application of criteria for determining significance and integrity. This chapter provides an overview of those tools used in the designation process.



In This Chapter:

- A. Designating Historic Properties
- B. Significance and Integrity
- C. Types of Historic Properties
- D. Defining Districts and Using Boundaries



A. Designating Historic Properties

The designation of individual properties and districts as historic is most often a decision that is made by a local governing body (i.e. Mayor/Council) through the adoption of an ordinance. However, some Colorado communities allow the Commission to designate an individual property or district as historic without an official Council ordinance. It is best to check with local city staff to determine what process is utilized in a particular community. If a designation ordinance is the procedure that is utilized, it should include findings that describe the historic, architectural, or archaeological significance of the property, the boundaries of the property, and reference the applicable ordinance or section of the local code that allows the Council to make the designation and review alterations to those properties.

Each local governing body determines who is able to nominate properties and districts for historic designation. Common groups that are permitted to nominate buildings include the owner of the property (or someone representing the owner with their consent), a citizen who is not the owner of the property (without owner consent), and the Commission itself or the Council/County Commission. The local governing body also determines what percentage of owners must agree to a District nomination; common percentages of owners include 25%, 51%, 75%, and 100%. History Colorado recommends that a super majority, or 75% of the owners, agree to the nomination for a District to be possible.

Designating a district can sometimes be a long and occasionally contentious process. The Commission should consider holding special informational meetings or forums with community groups and property owners to answer questions, dispel myths, and discuss the community's concerns prior to holding a formal vote on whether to recommend designation of a district. While these meetings are imperative for districts, they are not generally practical for the listing of an individual property, unless the property designation is contentious. Such outreach can be very important when it comes time to present the designation request to the City Council or Board of Commissioners.

Building support for designation

Informational meetings should be held in the early stages of the process such that property owners are well-informed and that their concerns can be addressed. While a failed designation may be the result of a variety of factors, building community support for an individual property or district through education and a transparent public planning process is vital to a successful designation.

Main Street programs can assist through the use of their annual work plans which often help organize volunteers and plan or facilitate meetings. Main Street is primarily a partnership which focuses on the core area of a walkable commercial district. Neighborhood associations can play a similar role when involved in residential areas. Non-profit organizations are also strong partners for this process as they often have a large group of members that can help support designation of a historic property.

What is the commission's role?

The local preservation commission reviews designation applications/nominations and makes a recommendation to the elected body. In some communities the Planning Commission also reviews designation materials. Each community determines what group has the authority to designate properties and districts; in some communities only the Council/County Commission have the authority to designate, while in other communities, the Commission has the authority to designate with the Council/County Commission becoming involved upon appeal.

The steps in the designation process

Survey is often the first step in the designation process if the survey results indicate a property or district is eligible for designation. However, a survey is not required for a nomination to occur nor does a survey itself initiate designation. The steps listed below are the typical steps for the nomination process.

STEPS IN A LOCAL ORDINANCE:

The steps listed here may vary from those in some local ordinances. Always check for any differences.

NOTE:

Chapter 10 provides more detail about hearing procedures.





1. Prepare the nomination.

Include descriptions of significance along with key features and other data as specified in the ordinance and rules and procedures. The nomination should include a statement that describes why the property/district is significant and relates it to the criteria published in the ordinance.

2. File the nomination with the HPC.

Check for completeness of documentation before continuing.

3. Schedule an HPC hearing.

Provide public notice, as required in the ordinance.

4. Preservation commission decision

The commission's action is a recommendation to the governing body and/or an official designation based on the local ordinance.

5. City Council/county commissioners hearing

Also conducted according to due process requirements, including appropriate public notice.

6. Appeal

Follow the process specified in the ordinance. This will indicate the venue for the appeal.

B. Significance and Integrity

Age of historic resources

As will be discussed in Chapter 10, age requirements for nomination vary greatly between localities. In many cases, 50 years old is recognized as the standard for evaluation for potential historic significance, although the City and County of Denver has established a 30 year age requirement, and the City of Greeley has no age requirement.

Secretary of the Interior’s criteria

To be eligible for designation as a historic resource, a property must demonstrate significance in terms of criteria that are adopted. Most local governments apply criteria adapted from those established by the Secretary of the Interior:

- Association with events or trends important in the history of the community
- Association with individuals who made a demonstrable and lasting contribution
- Architectural merit
- The potential to yield information that will contribute to a better understanding of our past (archaeological)
- The State Register of Historic Properties and many local ordinances add the criteria of geographic importance of a property, referring to its location and its recognition as a visual landmark

History Colorado provides more information on evaluation criteria. <https://www.historycolorado.org/preservation-planning-unit-resource-center-0>

Aspects of integrity

In addition to demonstrating significance, a property must retain physical integrity to reflect that significance; it must not have been substantially altered since the period of historical association. This period of significance can be determined in a variety of ways. Many times, it is determined from the original construction date, but depending on the period of significance for the district, alterations since the original construction date will also be considered significant. If alterations fall within the period of significance, it is appropriate to say the property maintains its integrity for that period, therefore rehabilitations to that alteration period will be considered appropriate.

Integrity includes the aspects of location, design, setting, materials, workmanship, feeling, and association. A majority of the resource’s structural system and materials and its key character-defining features should remain intact. For more information, see Colorado Cultural Re-

PERIOD OF SIGNIFICANCE:

The time during which a property or district experienced events and activities of significance is termed its “period of historic significance.” It typically begins from initial construction or early development up through the end of a defined date. A period of significance is often used in identifying properties of historic significance for the National Register of Historic Places, as well as local and state designations.

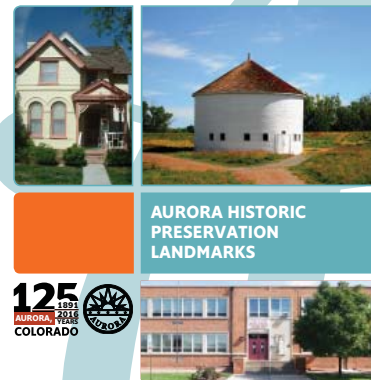



source Survey Manual at <https://www.historycolorado.org/sites/default/files/media/document/2017/1527.pdf>.

What are character-defining features?

Every old building is unique, with its own identity and its own distinctive character. Character refers to all those visual aspects and physical features that comprise the appearance of a historic building.



The presence of key character-defining features helps determine a property's integrity. Character-defining elements include the overall shape of the building, its materials, craftsmanship, and decorative details, as well as the various aspects of its site and environment. Some basic character-defining feature categories include:

- Shape of the building overall (simple rectangle, complex composition)
- Roof shape (sloping, flat)
- Roof details (eaves, rafters)
- Openings (windows and doors)
- Projections (porches, turrets, bay windows)
- Trim and other components (decorative elements, railings, shutters)
- Materials



The following illustrations identify character-defining features on two different property types.

Identifying character-defining features on individual buildings

Character-defining features may be illustrated in surveys, historic guidebooks and design review guidelines. These documents help property owners identify those elements that should be respected when making improvements.

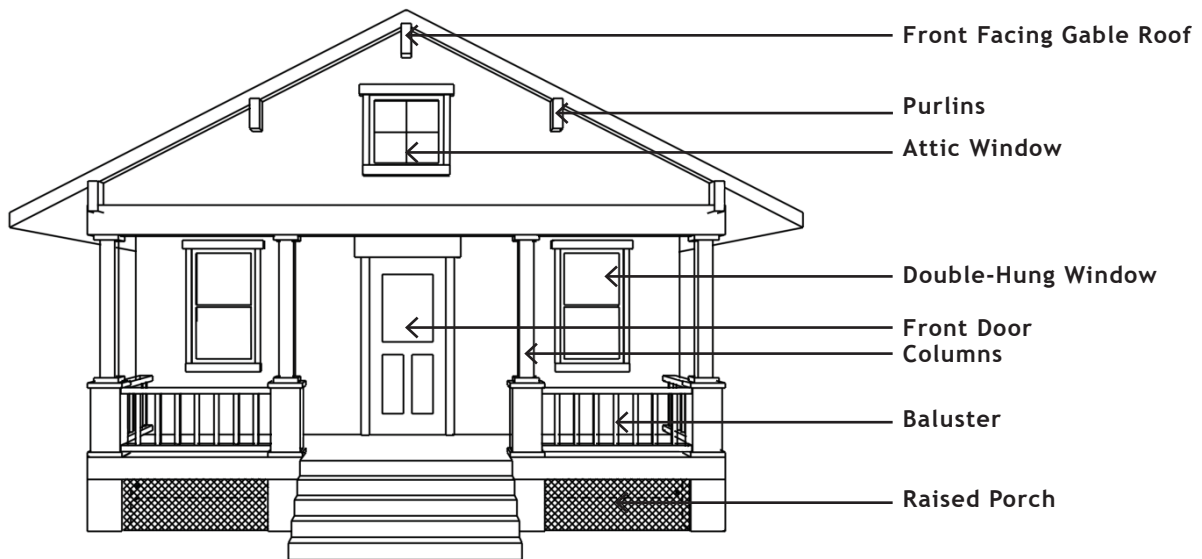
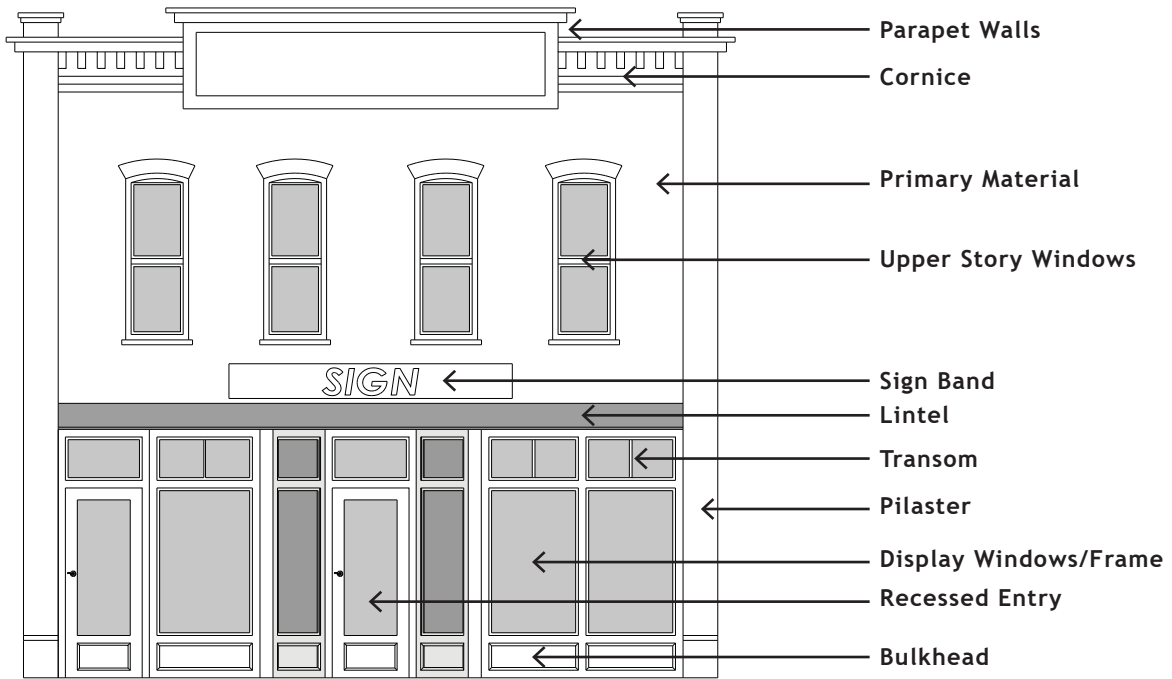

Character-defining features in a historic district

In a historic district, many buildings may share similar design features, even when the buildings span several decades or represent different architectural styles. When these features are repeated along the street, they contribute to a sense of visual continuity, which in itself can be a key character-defining feature. Understanding these district-level features is particularly important when evaluating proposals for new construction in a historic district.



These three commercial buildings in a historic district, although of different heights and periods of design, share these elements: 1. Base, 2. Middle, and 3. Cap.



In many commercial districts, similarity of floor heights at the street level, and horizontal moldings combine to create a horizontal alignment that establishes a distinctive scale for a block, which is a character-defining feature.

Character-defining features in a historic district, continued

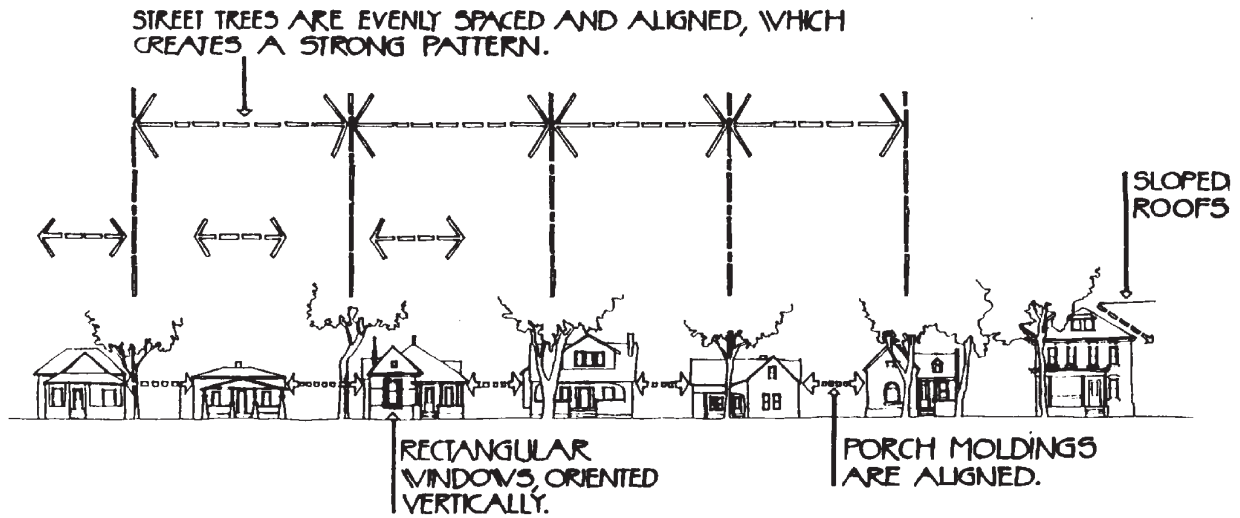

The uniform spacing of buildings and side yards creates a rhythm of house fronts in many residential districts, which is character-defining.

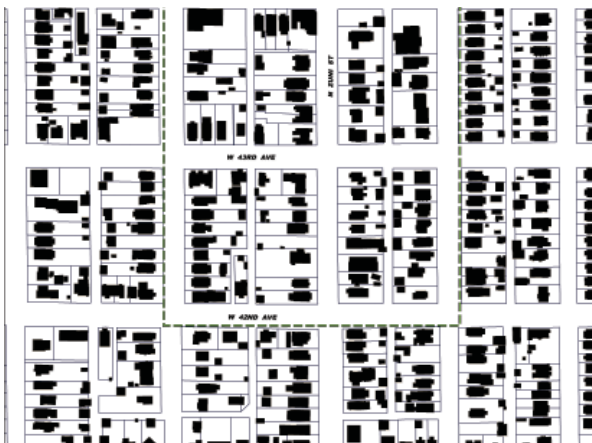

The arrangement of city blocks, the width of streets, and the presences of alleys are often key features of many single family residential districts. Aerial photographs and "figure-ground" maps also illustrate the uniform setback of building fronts and consistent orientation to the street.



An archaeological resource is a property type.

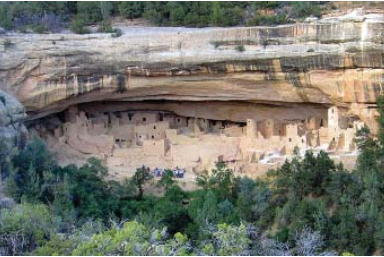

C. Types of Historic Properties

Historic properties come in a variety of forms. These are the typical categories:

Building

A structure intended to shelter some sort of human activity. Examples include a house, barn, hotel, or church.

Structure

A functional construction meant to be used for purposes other than sheltering human activity. Examples include, an aircraft, ship, grain elevator, or bridge.

Site

A discrete area significant solely for activities in that location in the past, such as a battlefield or designed landscape (parks and gardens), as well as a place with archaeological resources.

Object

Usually artistic in nature, or small in scale when compared to structures and buildings, and generally associated with a specific setting or environment. Examples of objects are monuments, sculptures and fountains.

Historic district

A geographically definable area, possessing a significant concentration of sites, buildings, structures, or objects united by past events or aesthetically by plan or physical development.

Cultural Landscape

A geographic area, including cultural and natural resources and its wildlife or domestic animals, associated with a historic event, activity, or person. Four types of cultural landscapes include historic sites, historic designed landscapes, historic vernacular landscapes, and ethnographic landscapes.

Other categories also are used. These include:

- Traditional cultural property
- Maritime sites

Designated Local Historic Districts

City of Boulder, Colorado

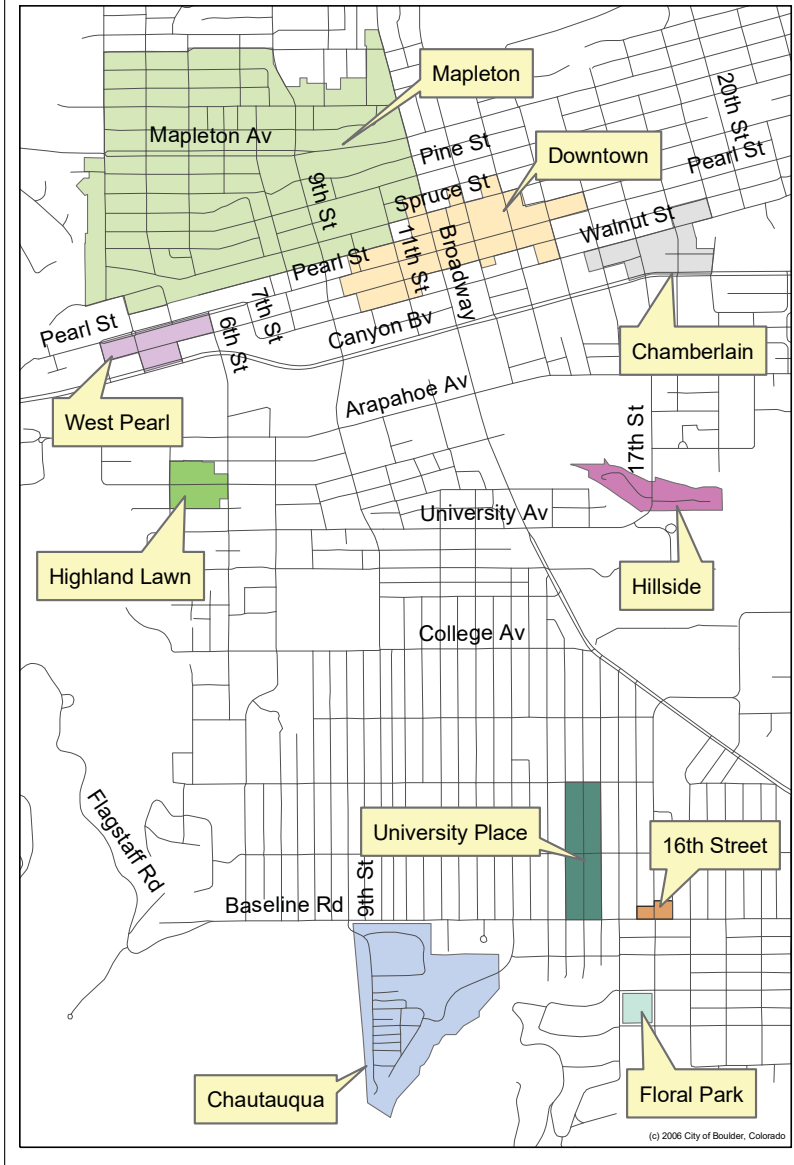

Map showing diversity of historic districts in one community.

Individual landmarks and districts

Properties identified as having historic significance and formally designated to a local historic register may be listed individually (usually termed a “landmark”), or as a contributing resource in a historic district.

Contributing vs. non-contributing properties

When a boundary is defined for a historic district, it will be drawn around all of the properties in the area. Each of these is then classified as “contributing” or “non-contributing” to the district’s historic significance. Each property is first identified as such in a historic resource survey, which is then formally adopted when the district is designated.

Contributing property

A “contributing” property is one which has been determined to be historically significant and have sufficient integrity. It is any building, structure, object or site within the boundaries of the district which reflects the significance of the district as a whole, either because of historic associations, historic architectural qualities, or archaeological features. Also important to note is that



for a property to be contributing, it must also have been constructed within the District’s period of significance. If it was constructed before or after the specified period of significance, the building can be individually listed, but will not be contributing in the District.

Another key aspect of the contributing property is historic integrity. There are some alterations that may lead a property owner to believe a building has lost its historic integrity. These alterations include window replacements, cornice replacement, a porch enclosure, or a change/covering of a building’s original materials or storefront, for example. These alterations can be reversed and/or restored to reveal a building’s historic integrity enabling the building to be contributing once the reversal or restoration is complete.

Non-contributing property

In a historic district, those properties that do not have

BUILDING INTEGRITY



“Contributing” Property. This building retains a high degree of integrity.



“Contributing” Property with some alterations. Although its integrity is diminished, this building may still be considered a contributor. However, it would unlikely be eligible as an individually listed landmark.



“Non-Contributing” Property with major alterations. This building does not retain a sufficient degree of integrity.

FACTORS TO CONSIDER IN ESTABLISHING DISTRICT BOUNDARIES:

Historical Factors:

- Original settlement boundaries
- Concentration of building

Visual Factors:

- Views
- Gateways
- Topography

Physical Factors:

- Railroads, highways
- Major urban spaces
- Rivers, natural features
- Changes in land use
- Walls, fences
- Limits of settled areas

Surveyed lines and lines of convenience

- Legal boundaries
- Streets and right-of-way
- Property lines
- Uniform setbacks

NOTE :

In many cases there may be differences between a National Register district boundary and that of a local district.

historic significance are termed “non-contributing.” This does not indicate that the property is incompatible in its character with the district; that is a different consideration.

A “non-contributing” building is one that is outside the period of significance, or a building that has been substantially altered that does not retain its historic integrity.

Generally any building within a historic district that was constructed within the period of significance and retains integrity to the period of significance, will be contributing. The building does not need to have individual significance, it just needs to relate to the overall themes/patterns that make the historic district significant. However, a property may be rated as non-contributing for these reasons:

- It was constructed outside the period of significance to the district
- Was constructed within the period of significance, but is substantially altered outside the period of significance and therefore has lost its integrity (i.e., a significant change in building form, the removal of a front porch, a reconfiguration of front facade windows, the removal of a storefront, etc.)
- There is insufficient information to determine that the property has historic significance
- Infill construction which might be compatible in design and an appropriate solution to a vacant lot, but would not be considered a contributing structure because it was constructed outside the period of significance (refer to Chapter 7 for more details on infill construction)

D. Defining Districts and Using Boundaries

What does a district boundary include?

Local boundaries are drawn to contain all of the contributing resources that are identified. They also may be influenced by land use planning policies as well. New construction in the immediate context can affect one’s



A map of a potential historic district in Mackinac Island, Michigan, shows all buildings within the boundary. Contributors are identified in red; non-contributors in brown. Other structures, including two wharves, a stone retaining wall and a breakwater, are also identified as contributing resources.

Commissions use this information when designating historic districts and also in the design review process to consider the context of a project and the significance of the resource at hand.

perception of the historic character of the district and for this reason, the boundary may include vacant land and blocks that face historic properties.

Environmental setting and landscape features

Districts often include a combination of buildings, structures, landscapes, and site features, such as fences and walls.

Relationship to zoning, other boundaries

In addition to considering context for purposes of design review, boundaries may also be drawn to align with underlying zoning boundaries, special planned development areas, or other local demarcations. (See Chapter 2.)

“Opt in” and “opt out” of a district

History Colorado does not permit CLGs to form districts where individual property owners can decide whether to “opt in” or “opt out” of the District. If a district is designated, all buildings will be included and determined as contributing or non-contributing.

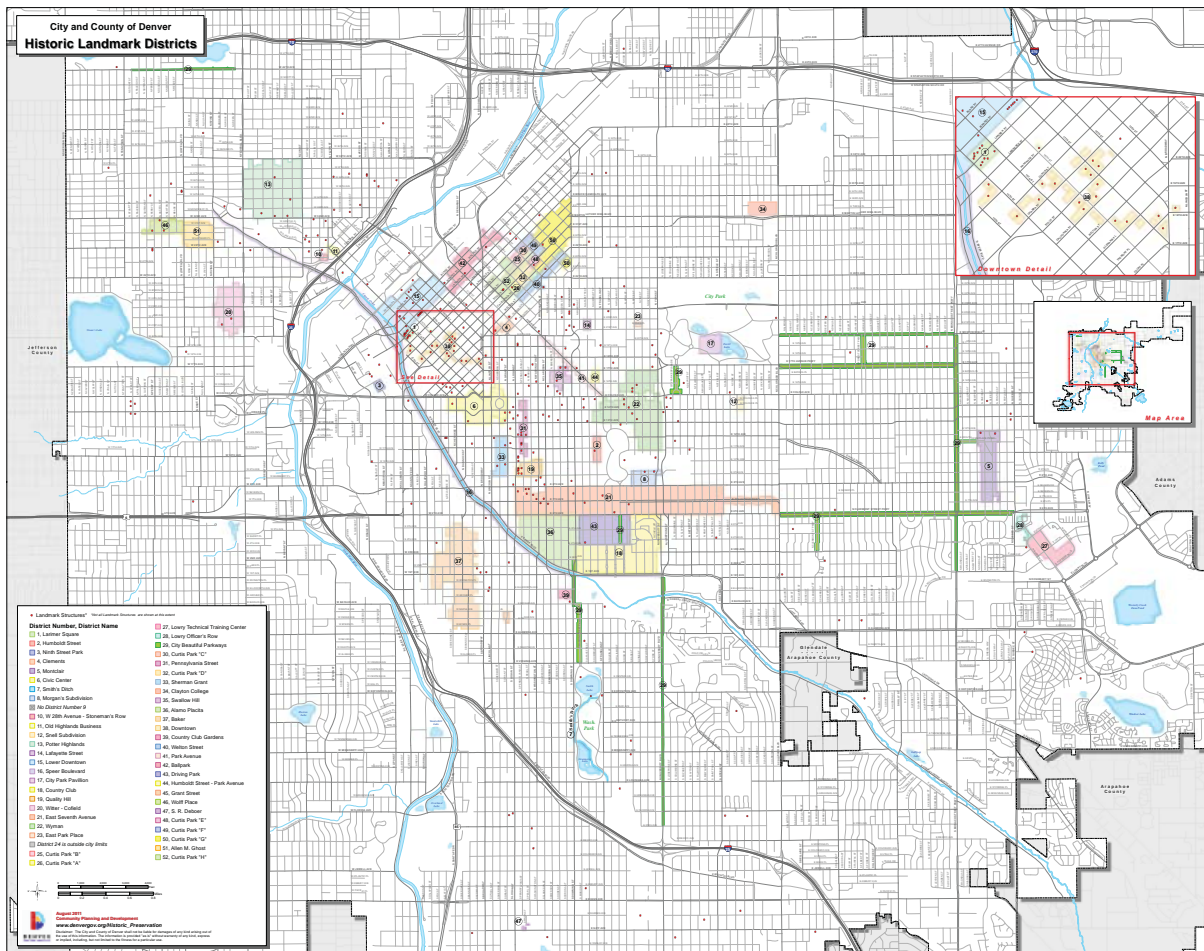

CHAPTER 6: TREATMENT OF HISTORIC PROPERTIES

Once historic resources are officially listed in a local register, and if the preservation ordinance provides for a Certificate of Appropriateness process, the commission will be engaged in conducting design review. The process of reviewing is described in a subsequent chapter (Chapter 7), but first, it is important to consider how one determines which elements of a property constitute its key, character-defining features and how the basic principles of preservation should be applied. This includes consideration of the reasons for a property’s historic significance and of the different types of “treatment” that may be applied. This chapter addresses these basic principles and illustrates some examples of how they may be published in design guidelines.



In This Chapter:

- A. Determining What’s Important to Preserve
- B. Basic Preservation Principles
- C. Alternative Treatments for a Historic Property
- D. Applying These Principles
- E. Design Guidelines



NOTE :

See the discussion in Chapter 5 about the process of identifying key features.

A. Determining What's Important to Preserve

Before reviewing a proposal, it is important to identify the key features that contribute to the significance of a historic resource. This may in part depend upon the type of resource and whether it is individually listed or is contributing to a district. In either case, designation forms should call out the key features of the building or district.

Individual landmarks

For individually listed landmarks, great care should be taken to identify all the key features that should be preserved. For properties that are highly significant, this may include features on all sides of the building. This is especially true for buildings that are visible from multiple public right-of-ways.

Significance and integrity of a contributor

In a historic district where many contributors are perceived in a grouping, and sides and rear walls are less visible, features in remote locations may be less critical to the significance of the property, and more flexibility in their treatment may be an option. This will depend, however, upon careful consideration of the context and the reasons for significance.

Setting priorities for key features

For many buildings, facades seen from the public way often contain more key character-defining features than other facades. A series of sketches (on the following page) illustrates a method of evaluating the priorities for preserving key features.

- Primary facade: Highly valued character-defining features
- Secondary wall: Moderately high value, with fewer character-defining features
- Rear wall: Few character-defining features

Locating Facade Treatments

For many historic resources, the front wall is the most important to preserve intact. Alterations are rarely appropriate. Many side walls are also important to preserve where they are highly visible from the street. By contrast, portions of a side wall that are not as visible may be less sensitive to change. The rear wall is usually the least sensitive, and alterations can occur more easily without causing negative effects to the historic significance of the property. This concept of evaluating the different faces of a building to locate the appropriate places for alterations is illustrated in the sketches below.

Location A: Primary Facade

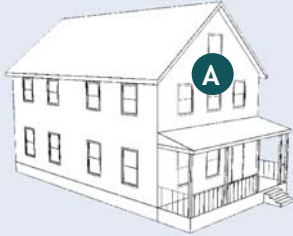

- Location A: Preservation and repair of features in place is the priority.
- This is especially important at the street level and in locations where the feature is highly visible.

Location B: Highly Visible Secondary Wall Location C: Less Visible Secondary Wall

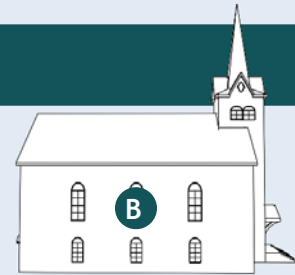
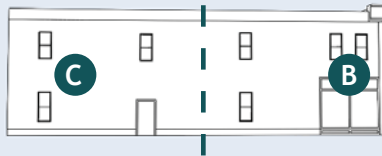
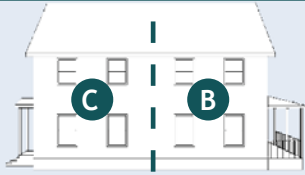

Location B: Preservation is still preferred.

- Preservation and repair in place is the priority.

Location C: Preservation is still preferred.

- A compatible replacement or alteration is acceptable.
- More flexibility in treatment may be considered.

Location D: Not Highly Visible Rear Wall Location E: Potentially Visible Rear Wall



Location D: Preservation is still preferred.

- A compatible replacement or alteration may be acceptable when it is not visible to the public.
- More flexibility in treatment may be considered.

Location E: Preservation is still preferred.

- Preservation and repair in place is the priority.
- Some flexibility may be considered on upper facades.

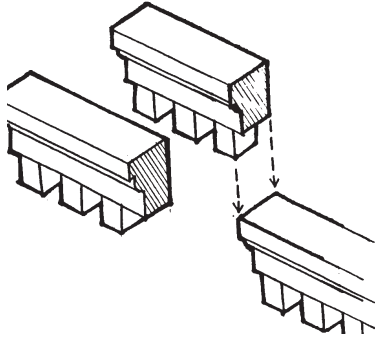

When replacement is required, replace only those portions deteriorated beyond repair. Retain as much of the original fabric as possible.

NOTE :

The Secretary of the Interior's Standards for the Treatment of Historic Properties can be found at: <http://www.nps.gov/tps/standards.htm>

This analysis is more relevant in historic districts, where collections of buildings are contributors. Many individual landmarks may have highly valued features on all building faces.

B. Basic Preservation Principles

With an understanding of the basic concepts of historic significance and integrity, it is important to comply with some overarching principles that underlie any appropriate treatment of a historic resource. The following principles should apply to all cases:

Principle 1. Preserve key features.

- A fundamental concept is that those character-defining elements that convey a property's significance should be preserved. This may include features from different time periods that demonstrate the evolution of the property over time.

Principle 2. Retain integrity.

- Preservation theory places value on retaining historic fabric wherever possible.
- While some properties may already have lost some integrity, any further loss in integrity is inappropriate.

Principle 3. Respect the historic character of a resource.

- Don't try to change the style of a historic resource or make it look older than its actual age.
- Confusing the character by mixing elements of different styles or periods can adversely affect the historic significance of the property.

Principle 4. Seek uses that are compatible with the historic character of the resource.

- Converting a building to a new use different from the original use is considered to be an "adaptive use." For example, converting a residential structure to a bed and breakfast is an adaptive use.

- While commissions do not have jurisdiction over how a property is used, only how it is altered, changes in use requiring the least alteration to significant elements are preferred. In most cases, designs can be developed that respect the historic integrity of the resource while also accommodating new functions.

C. Alternative Treatments for a Historic Property

While most of the work that a commission will review is considered to be “rehabilitation,” there are four categories of treatment that are recognized. These are based on definitions established by the Secretary of the Interior. These treatments are:

Rehabilitation

“Rehabilitation” is the process of returning a property to a state that makes a contemporary use possible while still preserving those portions or features of the property which are significant to its historical, architectural and cultural values. Rehabilitation may include a change in use of the building or additions. This term is the broadest of the appropriate treatments and is often used in local design review guidelines. See page 97 for rehabilitation standards.

Preservation

“Preservation” is the act or process of applying measures to sustain the existing form, integrity and material of a building. Work focuses on keeping a property in good working condition with proactive maintenance. While the term “preservation” is used broadly to mean keeping a historic property’s significant features, it is also used in this more specific, technical form in this document.

Restoration

“Restoration” is the act or process of accurately depicting the form, features and character of a property as it appeared in a particular time period. It may require the removal of features from outside the restoration period. This may apply to a building front, or to restoring a particular missing feature.

TREATMENT OF AN ALTERED CORNICE:

Existing Building



Existing building with missing cornice.

Reconstructed Cornice



Reconstruct a missing cornice when historic evidence is available.

Replaced Cornice



A simplified interpretation is appropriate if evidence of the original is missing.

PREFERRED SEQUENCE OF IMPROVEMENTS:

Preserve

Repair

Reconstruct

Replace

Compatible Alteration

Reconstruction

“Reconstruction” is the act or process of depicting, by means of new construction, the form, features and detailing of a non-surviving site, landscape, building, structure or object for the purpose of replicating its appearance at a specific time and in its historic location. This has limited application, in terms of an entire building, but may apply to a missing feature on a building. Note: accurate historic documentation is needed before undertaking.

The basics of a rehabilitation approach

The following steps show the preferred sequence for the treatments in combination with other work that may occur. When making a selection, follow this sequence:

Step 1: Preserve

If a feature is intact and in good condition, maintain it as such.

Step 2: Repair

If the feature is deteriorated or damaged, repair it to its original appearance.

Step 3: Reconstruct

If the feature is missing entirely, reconstruct it from appropriate evidence. Also, if a portion of a feature is missing, it can be reconstructed.

Step 4: Replace

If it is not feasible to repair the feature, then replace it with one to match the original (i.e., similar in design, materials, detail, finish). Replace only that portion which is beyond repair.

Step 5: Install compatible alterations

Once the key character-defining features have been appropriately treated, identify the necessary alterations that may be needed to extend the viability of the property. If a new feature or addition is necessary, the design should minimize the impact to original features. It is also important to distinguish new features from original historic elements.

This chart diagrams a linear process for determining the appropriate approach for treatment of a historic building.

Step 1: Why Is The Property Significant? Determine its Significance

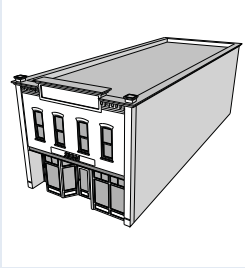

Building significance. Understanding the history of a building is important to any preservation project. Where it is available, survey information available in the Planning Department should be consulted to help identify the building's age, style and its key character-defining features. This will help determine to what degree the property should be preserved as it is, or where there may be opportunities for compatible alterations to occur.

Step 2: What Is The Condition Of The Property And Its Key Character-Defining Features?

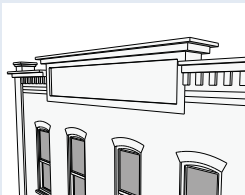

Integrity. The condition of a building and its features contribute to the overall significance of the building. A building with historic integrity has a sufficient percentage of character-defining features, and key features remain intact. These key elements allow a building to be recognized as a product of its time.

Step 3: What Is The Desired Project?



Building use. Are any functional improvements needed for the desired building use? Or is preservation of character-defining features the objective? If restoring features is the focus, then other alternative design approaches may not be necessary, but if some functional improvements are needed, then compatible alterations and/or additions may be the approach.

Step 4: What Is The Treatment Strategy

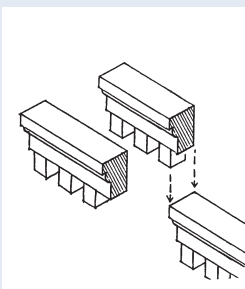

Treatment strategy. A preservation project may include a range of activities, such as maintenance of existing features, repair of deteriorated materials, the replacement of missing features and construction of a new addition. While the term "preservation" is used broadly to mean keeping a historic property's character-defining features, it is also used in a more specific, technical form to mean keeping a resource in good condition. This, and other related terms, are important to understand because they are all used when planning for improvements to a historic property.

D. Applying These Principles

These next few pages illustrate ways in which basic principles for preservation can be applied.

Case Study 1: Commercial façade rehabilitation

This project illustrates a combination of the four treatments for a historic property: Some original features that survived were PRESERVED and some were RESTORED where damaged, while some missing features were RECONSTRUCTED, and some new, compatible elements were introduced. Overall this would be considered a REHABILITATION project.

Original Character:

In 1979, the addition of wood paneling obscured the historic storefront on the Miller Block in Fort Collins, CO.

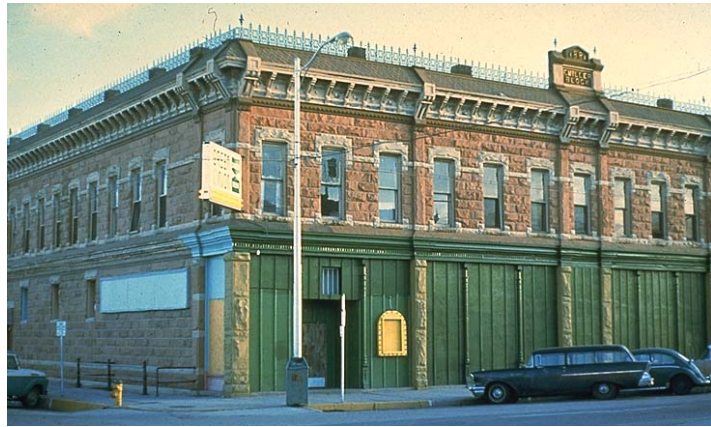

After Rehabilitation:

Shortly after construction of the plaza in Old Town Square (ca. 1985), new awnings define the dimensions of individual storefront bays.



Current Condition:

In 2013, key features remain preserved. Different awning colors distinguish individual businesses while retaining the overall visual continuity of the building.



Case Study 2: Adaptive reuse project

This project illustrates the adaptive reuse of a historic property, from an institutional function to a mix of commercial and residential uses. Surviving features were PRESERVED and RESTORED, while missing features were reconstructed. A new, contemporary storefront was added to distinguish old from new.



Original Character:

- Offset tower
- Bracketed cornices
- Stone window sill and arches
- Double hung windows
- Fire door
- Storefront
- Brick facade



Interim Condition:

- Tower missing
- Cornices missing
- Stone trim damaged
- Upper windows altered
- Fire door altered
- Storefront missing
- Brick damaged



After Rehabilitation:

- Tower reconstructed
- Cornices reconstructed
- Stone trim repaired in place
- Upper windows replaced to match original
- Fire door shape restored, with contemporary storefront
- Storefront reconstructed

Case Study 3: Applying preservation principles to the treatment of an altered historic porch

In this case study, two alternative design approaches are considered for a porch that has been substantially altered.

Existing Altered Porch



- Porch posts are missing
- Porch area is enclosed

Treatment 1: Reconstruction



When Should I Use This Approach?

- The building is highly significant
- There is good historical information about the design
- The needed materials and craftsmanship are available
- The project budget permits
- The context has many intact historic buildings

Treatment 2: Replace



When Should I Use This Approach?

- The building is a contributor to the district
- There is less historical information about the original design
- The budget is more limited
- The work will be phased

Case Study 4: Applying preservation principles to the design of an addition

In this case study, a series of alternative massing studies illustrate the potential effect upon one's perception of the character of the historic resource. A large scale addition overwhelms the character of this property. In this case, a single family house is the subject. A small scale addition, set to the rear, is the best solution, because it will have less of an effect upon the integrity of the original building.

Original Structure

The one-and-a-half story bungalow illustrated at the right is a contributing structure in a locally-designated historic district.

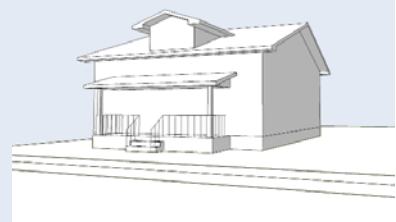
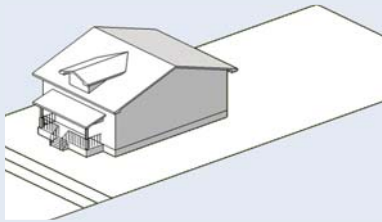

One-Story Attached Addition

The one-story addition illustrated at the right is appropriate because it is clearly differentiated from the original structure with a change in roof plane and is nearly invisible from the street.

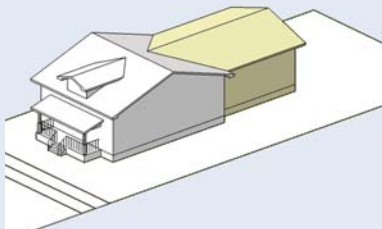

One-and-a-Half Story Addition with Connector

The one-and-a-half story addition illustrated at right is appropriate because it is set back and clearly differentiated from the original structure with a connector.

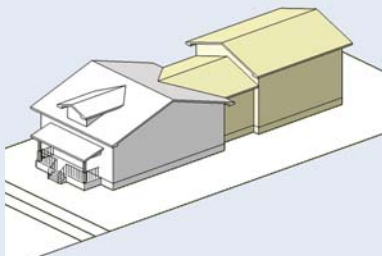

Inappropriate Two-Story Roof-Top Addition

The roof-top addition illustrated at right is inappropriate because it substantially alters the primary façade of the historic structure.

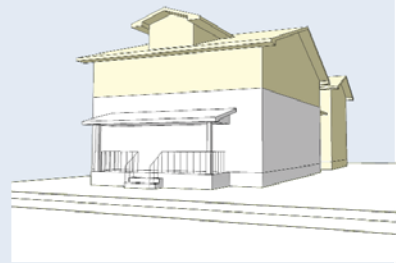
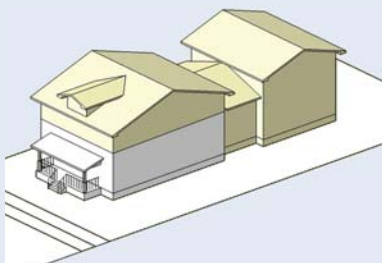

Pitkin County, Colorado



Preservation Handbook for Historic Properties



August 27, 2008

Design Guidelines for the Historic Business District & Local Landmarks

Town of Pagosa Springs, Colorado
A Certified Local Government

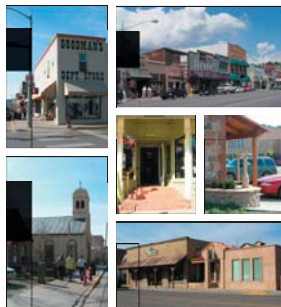

Adopted July 3, 2007
Revised May 2, 2015
by Town Council Resolution 2015-07

GUIDELINES VS STANDARDS:

The term “standard” is used to describe a prescriptive, measurable requirement that must be met in order to gain a development permit, and the term “guideline” typically means a criterion that is used in determining appropriateness through a more discretionary review process.

E. Design Guidelines

An essential ingredient of the review process is an adopted set of guidelines. Commissioners should refer to their design guidelines for all project reviews.

What are design guidelines?

Design guidelines are criteria that guide commissions and property owners on historic resource treatment decisions. They are usually a separate document from the ordinance, but basic guidelines may be included in the code itself. In all cases, the guidelines should be associated with a set of criteria for appropriateness that are set forth in the ordinance. Guidelines typically are adopted by resolution of the governing body.

Guidelines enable local preservation commissions to make consistent and fair decisions when property owners seek to renovate or construct new buildings in a historic area.

Design guidelines typically address both rehabilitation and new construction in a historic district. Most guidelines also address signage, site design, demolition, relocating structures, streetscapes and treatment of individual landmarks. Locally adopted design guidelines should be consistent with best practices in the field of preservation, including the Secretary of the Interior’s Standards for the Treatment of Historic Properties.

Preservation Topics

These guidelines focus on preserving the integrity of historic resources.

New Construction Topics

These guidelines focus on assuring compatibility with the setting in historic districts. Building form, mass and scale are major topics.

Guidelines for Existing, Non-Contributors

The guidelines for new construction are usually applied to non-contributors. That is, compatibility is the objective, not preservation of specific building elements.

Key design guidelines components - sample guideline

These are recommended components of locally-crafted preservation design guidelines.

- A** → **Architectural Details**
Historic features, including original materials, architectural details and window and door openings, contribute to the character of a structure. They should be preserved when feasible.
- B** →
- C** → **1.1 Preserve significant stylistic and architectural features.**
 - Storefronts, cornices, porches, turned columns, brackets, exposed rafter tails and jigsaw ornaments should be preserved.
- D** →



Protect and maintain significant stylistic features, such as these window features, cornice details and ornaments.

Key

A **Design Topic**
Describes the design topic addressed by the design guidelines that follow.

B **Policy Statement**
Explains the desired outcome for the design topic and provides a basis for the design guidelines that follow. If a guideline does not address a specific design issue, the policy statement will be used to determine appropriateness.

C **Design Guideline**
Describes a desired performance-oriented design outcome.

D **Additional Information**
Provides a bulleted list of suggestions on how to meet the intent of the design guideline.

E **Images**
Clarify the intent of the design guideline by illustrating appropriate and inappropriate design solutions.

Design Guidelines for Denver Landmark Structures & Districts



LANDMARK PRESERVATION
COMMUNITY PLANNING &
DEVELOPMENT
JANUARY 27, 2016



FOR MORE INFORMATION:

Helpful resources to consult for writing design guidelines for historic preservation can be found at <https://napcommissions.org/online-design-guidelines/>

How are guidelines used?

These are three key uses of design guidelines:

1. As an educational tool

Guidelines are used to inform the general public and property owners of best practices in the treatment of historic resources.

2. In advance planning for a project

Property owners should turn to the design guidelines in the early stages of planning an improvement project.

3. In commission decision-making

And, of course, they are an essential tool in making informed and defensible decisions in the formal review process. To issue a certificate, the commission must find that the activity complies with all the relevant design guidelines.

How do local guidelines relate to the Secretary's Standards?

The Secretary of the Interior publishes the Standards and Guidelines for the Treatment of Historic Properties (36 CFR Part 68), which includes a specific set of guidelines for Rehabilitation. Local guidelines should be consistent with these principles.

Are “guidelines” enforceable?

This is a semantic issue that many commissions face. Some people interpret the term “guideline” to mean that they are suggestions, not regulations. In fact, they are enforceable, when clearly linked to broader criteria in the ordinance. The guidelines in essence help to interpret those criteria. Some communities, in order to make this enforceability clear, instead use the term “standards,” or the combined term “standards and guidelines.”

What if we don't have guidelines?

While locally-tailored guidelines are preferred, the National Park Service's Illustrated Guidelines for Rehabilitating Historic Buildings can serve very well, and many communities adopt them. Because they are written to apply to contexts throughout the nation, they are broad in nature and require careful interpretation.

Secretary of the Interior’s Standards for Rehabilitation

1.	A property shall be used for its historic purpose or be placed in a new use that requires minimal change to the defining characteristics of the building and its site and environment.
2.	The historic character of a property shall be retained and preserved. The removal of historic materials or alteration of features and spaces that characterize a property shall be avoided.
3.	Each property shall be recognized as a physical record of its time, place, and use. Changes that create a false sense of historical development, such as adding conjectural features or architectural elements from other buildings, shall not be undertaken.
4.	Most properties change over time; those changes that have acquired historic significance in their own right shall be retained and preserved.
5.	Distinctive features, finishes, and construction techniques or examples of craftsmanship that characterize a historic property shall be preserved.
6.	Deteriorated historic features shall be repaired rather than replaced. Where the severity of deterioration requires replacement of a distinctive feature, the new feature shall match the old in design, color, texture, and other visual qualities and, where possible, materials. Replacement of missing features shall be substantiated by documentary, physical, or pictorial evidence.
7.	Chemical or physical treatments, such as sandblasting, that cause damage to historic materials shall not be used. The surface cleaning of structures, if appropriate, shall be undertaken using the gentlest means possible.
8.	Significant archeological resources affected by a project shall be protected and preserved. If such resources must be disturbed, mitigation measures shall be undertaken.
9.	New additions, exterior alterations, or related new construction shall not destroy historic materials that characterize the property. The new work shall be differentiated from the old and shall be compatible with the massing, size, scale, and architectural features to protect the historic integrity of the property and its environment.
10.	New additions and adjacent or related new construction shall be undertaken in such a manner that if removed in the future, the essential form and integrity of the historic property and its environment would be unimpaired.

NEW COMMERCIAL BUILDING DESIGN

Mass and Scale

Traditionally commercial buildings had varied heights, articulated masses, visually interesting skylines and pedestrian-scaled street fronts that contribute to a sense of human scale. A new building should continue to provide a variety of pedestrian-friendly scales and visually appealing masses. Buildings should not be monolithic in scale or greatly contrast with those seen traditionally in Downtown Plano.

5.10 Maintain the traditional size of buildings as perceived at the street level.

- The street facing facade height of a new building should fall within the historic context of the area. It should respect the traditional proportions of height to width.
- Floor-to-floor heights should appear similar to those of traditional buildings downtown, especially those at ground level.
- For larger buildings new construction should incorporate design features, such as setbacks, that break down the mass into modules that suggest the underlying historic height, width and lot pattern.

5.11 Establish a sense of human scale.

- Use vertical and horizontal articulation design techniques to reduce the apparent scale of a larger building mass.
- Incorporate changes in color, texture and materials to help define human scale.
- Use architectural details to create visual interest.
- Use materials that help to convey scale in their proportion, detail and form.

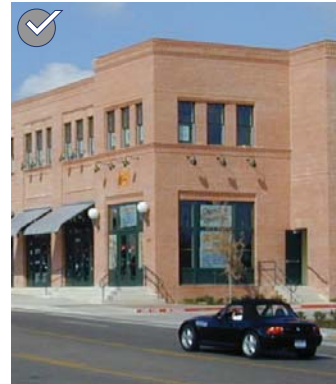

A new building should be designed with a pedestrian-scaled street front.



For larger buildings, new construction should incorporate design features that break down the mass into modules that suggest the underlying historic height, width and lot pattern.

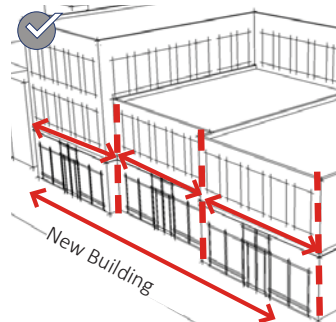

New facade widths should reflect the traditional range of the building widths seen on the block.

Compatibility for new construction is addressed in many design guidelines. The focus is on respecting the traditional mass and scale, orientation to the street and alignment of key features that occur in the commercial district. Imitating historic styles is discouraged.

CHAPTER 7: PROJECT REVIEW

A key responsibility for commissions is the review of proposals for work on historic properties and within historic districts. This requires careful consideration of the facts presented, with an objective application of the design guidelines that are adopted by the commission and of any criteria set forth in the preservation ordinance. If the commission finds that the work proposed meets those standards, it may authorize granting a Certificate of Appropriateness.



In This Chapter:

- A. What is the HPC's Scope of Authority?
- B. When is a COA Required?
- C. What are the Steps in the Review?
- D. Citing Design Guidelines
- E. Potential Actions
- F. Special Project Review





A. What is the HPC's Scope of Authority?

The scope of the commission's authority is usually defined in the preservation ordinance. This typically provides that they can review any exterior work on a property. In some cases, the ordinance may permit the local government to designate interiors as well, in which case those that are specifically listed will be subject to review.



While all CLGs must review changes that are more than in-kind repairs, some only have an advisory role. This role may simply mean providing comment on a proposal or recommending approval/denial to an administrative official or another board. In non-CLG communities, commissions may only have an advisory role. Rather than formally issuing a COA, they may recommend approval to an administrative official or another board. In this case, a simpler resolution in support may be adopted.

What if other repairs appear to be needed?

The commission is limited to considering the work described in the application for the COA. It cannot withhold approval of the COA because commissioners believe other improvements also should occur.

For example, if an original window has been replaced with an incompatible one, and replacing it with one to match the original would be desirable, the commission cannot require doing so, if work on that window is not in the application.

May the commission make design changes?

The commission should resist the temptation to redesign the project that is proposed. Instead, it should provide direction to the applicant that would guide them in making revisions that are more compatible with the design guidelines.

What if work is undertaken without a COA?

The building or zoning official is responsible for enforcing violations, but commissioners may often be the first to notice those conditions and will notify the code official.

B. When is a COA Required?

The first step is to confirm that a project is within the review powers of the commission, and that a Certificate of Appropriateness is required.

Most commissions require approval for these actions:

- Construction
- Alteration
- Reconstruction
- Moving
- Demolition
- Any other exterior change

In many cases, the application for a building permit triggers the application for a COA. However, some ordinances may require a COA for items that do not require a building permit.

Work not requiring a COA

Most commissions do NOT require a COA for routine maintenance that does not require replacing existing materials.

Routine maintenance

Repair that does not alter the character or finish of exterior materials does not require a COA. Examples include:

- Repainting, using the same color and type of paint
- Resecuring loose boards, shingles or other existing materials
- Such repairs that do not perpetuate an inappropriate condition



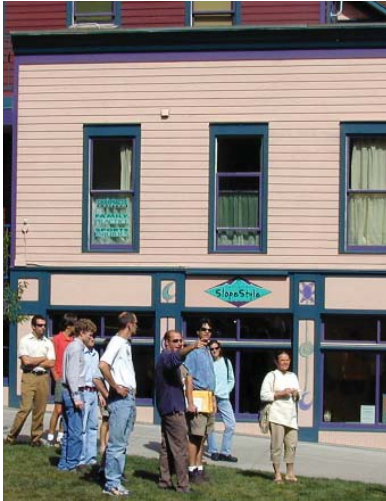

Commissioners should visit the site of any proposal that they will review. This will require a Public Notice if commissioners tour the site together.

UNACCEPTABLE DRAWING:

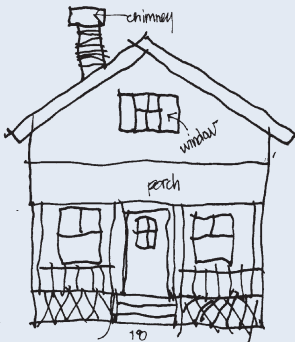

- Cannot be measured
- Lacks sufficient detail

Compare with sketches on the next page.

C. What Are the Steps in the Review?

Be certain to be familiar with each application, which should include the applicant's name and address, the property address, the property owner's information (if applicable), a project summary description, plan sets for the project, proposed project materials, photographs of the property, and any other information that may help in the review process. If it appears that a commissioner is unfamiliar with a proposal during a hearing, it can undermine the credibility of the decision.

These are best practices in project review that each commissioner should follow:

Before the meeting

1. Visit the site.

Commissioners should visit the site of the project in order to gain an understanding of the key features of the property and its context. In communities with a large volume of reviews, visits may not be practical. Be sure to follow any open meetings laws that apply to site visits.

2. Review background information.

Review surveys, documents, historic photos and other information about the property.

3. Confirm that submittal documents are complete.

Confirm that sufficient documentation is provided to adequately interpret the proposal and apply the guidelines. Staff may conduct this documentation review. Note that a checklist may be helpful to use as a reference.

A simple test to determine if the application documents are sufficient:

“If the finished work appears out of compliance, will the documents substantiate that fact? Can you prove non-compliance?”

4. Review the submittal documents and any staff reports.

Study them to determine the effects of the proposed work on character-defining features of the resource and its context. Commissioner should compare the proposal to Design Guidelines or Secretary of the Interior's Standards and be prepared to discuss how the proposal does or does not meet applicable Guidelines/Standards.

Special review questions

As you review an application, consider these questions to help focus the discussion:

1. What is the context?

What is the character of the setting and of adjacent buildings? Remember that you are reviewing the impact of a design upon its specific site, and if in a district, its surroundings as well as the property itself.

2. What is the impact of the proposal?

Will character-defining features be altered or compromised?

3. Which are the critical design issues?

Certain guidelines will be more applicable than others. Decide which ones will be most significant in reviewing the proposal before you.

Remember, you are interpreting the guidelines. If you disagree with their stated policies, the review session is not the time to assert your opinions about the guidelines themselves—only about the design in relation to the adopted guidelines.

4. Can the design issues be grouped?

Look for common themes. Often, discussion will ramble over many topics. Look for ways to simplify the debate by combining related issues.

5. Are non-design issues embedded?

Sometimes, the problem is not a design issue, but in fact it is a broader conflict over land use, density, or some other zoning policy that the guidelines cannot address or solve. Don't get sidetracked.

ACCEPTABLE DRAWING:



- Free-hand, but to scale
- Can be measured
- Has sufficient detail
- Adding dimensions to drawings can also be helpful

ACCEPTABLE DRAWING:



- Mechanically drafted
- Can be measured
- Has sufficient detail
- Adding dimensions to drawings can also be helpful

Compare with sketch on the previous page.

APPLICATION FOR CERTIFICATE OF APPROPRIATENESS

HISTORIC PRESERVATION COMMISSION
CITY OF ANYTOWN

Application is hereby made for the issuance
of a certificate of appropriateness under
Section 70, Article III of the Anytown Code of Ordinances.

(Please type or print clearly)

1. Location of Property: 1234 North Main Street
Street Address
Anytown, MD 12345-6789 321 D
City/State Zip Code Tax Map/Parcel#

2. Historic Designation: (Please check one and list the name of the historic resource)
 Historic District The Downtown Historic District
 Landmark
 Landmark Site

3. Applicant: Archie Teck 1 (800) 1-DESIGN
Name Telephone #
500 Important Place, Suite 362 Anytown, ST 12345-6789
Street Address City/State Zip Code
Applicant Is: Owner Lessee Architect Contractor Other
R. Ben Sprawl (987) 555-6543

4. Owner: (Name if different from applicant) Telephone #
678 Cul-de-sac Place Anytown, ST 12345-6789
Street Address City/State Zip Code

5. Type of Work: (Check one)
 Exterior Alteration or Repair
 New Construction/Addition
 Demolition of Structure
 Relocation of Structure
 Other

Proposed Elevation



Proposed Section

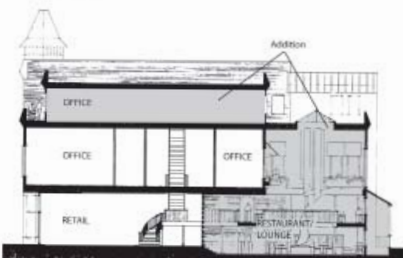

At the meeting

These steps are recommended for hearing an application. Note that some specific procedural requirements may vary in your local ordinance:

1. Introduce the Commission and the review process. Remember that some people attending the meeting don't know who you are! Explain the sequence of events. Be certain that the roles of the chairman, the commission members and their staff are understood.

2. Explain the purpose of the review. The purpose is to assure that the proposal meets criteria for a COA, as provided in the ordinance.

3. Call each case according to the published agenda. If deviations are required, announce this at the beginning of the meeting. Check for conflicts of interest.

4. Introduce the applicant and their project. Identify the location of the project (preferably on a map visible to all).

5. Listen to the staff report. If the Commission has staff, they should have reviewed the project in advance and may have a written report. Staff comments should identify the specific issues that this application raises and note how the project does or does not adhere to the guidelines.

6. Listen to the applicant's presentation. Encourage the applicant to relate their project to the appropriate sections in the design guidelines.

7. Ask for clarification. Withhold criticisms at this stage. First determine that everyone understands what has been presented.

8. Take public comments. Ask that their discussion be limited to the project at hand, and its relationship to adopted standards and guidelines. Record the name and address of speakers.

9. Take statements from other public agencies or organizations.

In some cases, code and enforcement officers and representatives from local historical societies or advocacy organizations may provide testimony.

10. Critique the proposal.

Next, the Commission should evaluate the proposal, using the design guidelines.

11. Allow the applicant to respond.

If the commission raises concerns, allow the applicant to defend the design as proposed, provide further explanation, or discuss modifications they will consider.

12. Entertain a motion.

The motion should be clear and direct. It should include a reference to the guidelines, and a finding that the project is approved or disapproved because it meets or does not meet the guidelines adequately.

There are four options for a motion:

- a. Approve as submitted.
- b. Approve with conditions for alterations to the submittal.
- c. Deny as submitted.
- d. Continue for additional information (being mindful of time limitations).

13. Vote on the proposal.

14. Summarize the results.

Be certain everyone understands the action just taken.

15. Record the decision.

Send the applicant a letter with the COA.



Routine maintenance usually is not subject to design review.

specification sheets

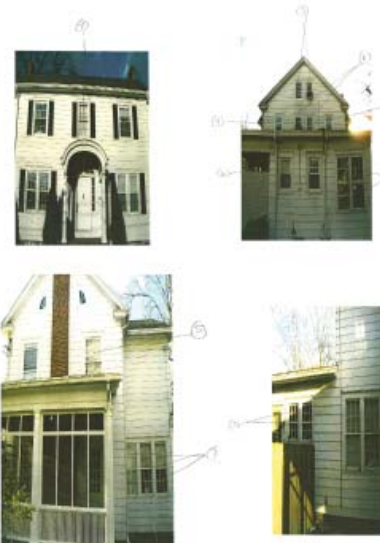

Annotated photographs as part of a COA application.



Use these techniques in your evaluation:

1. Use simple, clear language.

Be specific. Even if you approve the proposal, you want to give a clear message to future applicants and to future commission members about how you reached your decision, in the event that they, too, face similar issues.

2. Use the guidelines.

Use a checklist to confirm that you covered all the items, and then ask for discussion of any items that are in question. Allow open discussion, but monitor the content to avoid unnecessary repetition.

3. Keep the discussion moving.

When all the points have been made and people are repeating earlier comments, this is a good indication it is time to terminate the critique.

4. Keep the discussion on track.

Avoid “red herrings,” those tangential issues that may be emotionally charged, but have no direct bearing on the specific proposal, and are not addressed in the standards, and should not influence the decision. These can take up time, frustrate participants and confuse the decision-making record.

5. Do not include personal opinions.

Do not use the words “like” or “dislike” in the discussion of the appropriateness of the proposed changes. Instead, limit the discussion and critique to how a project does or does not meet the guidelines.



An analysis of key features of a historic district should be a part of submittal documents when context is a consideration. This is particularly important when reviewing new construction.

D. Citing Design Guidelines

As a means of interpreting those broad criteria to specific COA proposals, the commission should then apply its design guidelines. These may be the *Secretary of the Interior's Standards for the Treatment of Historic Properties*, or they may be locally tailored design guidelines. Many communities adopt the Secretary's Standards initially, and then augment them with locally crafted guidelines as time and budgets permit.

When reviewing a proposal, be certain to cite the guidelines. This makes it clear that the commission has made its decision objectively, using the tools that are officially adopted, not through personal taste or arbitrarily.

Design Guidelines for the Historic Business District & Local Landmarks

Town of Pagosa Springs, Colorado
A Certified Local Government



Adopted July 3, 2007

Revised May 5, 2015
by Town Council Resolution 2015-07

INFILL IN PLAIN ENGLISH:

New “infill” construction may occur as an addition to an existing building, or as a separate structure on a historic site or a parcel in a historic district.

Design guidelines for new construction focus on compatibility with the historic setting, not imitating it. In fact, new designs that pretend to look old are discouraged, because they confuse the record of history.

At the same time it is important that new development contribute to an overall sense of continuity while also conveying the evolution of the area. It can do so by reflecting more basic patterns of development in the district. Using similar building forms and materials, placing buildings in alignment with others in the block, and respecting the mass and scale of the context are examples.

Therefore, new buildings and additions should be distinguishable as such and not confuse one's interpretation of the development of the property or of the district. That is, each building should appear as a product of its own time.



E. Potential Actions

Once it is time for the commission to make a decision, these are the options:

Approve as submitted

No amendments are made to the submittal documents and no other conditions are attached.

Approve with conditions or modifications

An amendment may be made as a part of the motion to approve. This may be a change in what is proposed, as the applicant may elect to amend the application to better conform to the design guidelines, or an added stipulation. In some cases, the commission may approve with a requirement that a detail of the design be returned for approval later, either by the commission or staff.

Deny as submitted

If an application is denied, some ordinances provide that it may not be resubmitted for a year's time.

Continue the agenda item

If the applicant and the commission agree, a decision may be delayed in order for more information to be provided, or to allow the applicant to modify the proposal based on discussion at the hearing.

F. Special Project Review

In addition to the responsibility of reviewing proposals for work on historic properties and within historic districts, commissions in CLG communities can also be involved in additional ways for project components and special projects.

National Register Reviews

As a CLG, comment on all National Register nominations is required. Upon reviewing a nomination, a Commission will complete the "Colorado Certified Local Government National Register Nomination Review Report Form", which is sent to the CLG by contacting History Colorado. Within this form, the Commission may choose one of three recommendations:

1. The commission/board recommends that the nomination meets the criteria checked above.
2. The commission/board recommends that the nomination fails to meet any of the above criteria.
3. The commission/board chooses not to make a recommendation on the nomination. Attach an additional sheet explaining the lack of recommendation.

Upon review and completion of this form, commissions should also attach any additional comments such as information that can be added to enhance the nomination, any information they feel needs verification, etc.

Colorado Historic Preservation Tax Credit Review

A CLG community can elect to review Colorado Historic Preservation Tax Credits for residential properties at the local level, rather than directing the review to the SHPO. Local review is beneficial to property owners because they can then obtain historic designation, go through design review, and obtain certification for tax credits from one place, making the process much simpler. Additionally, because the standards for design review and the state historic tax credit program are one and the same, applicants can move forward on a project knowing that if they meet design guidelines, they can obtain a tax credit on many of their expenditures as well.

In order for a CLG community to receive this benefit to review applications for residential state tax credits, it must first adopt a resolution stating that they will act as a reviewing entity for the purpose of the program. With this resolution in place, a CLG can then review projects, collect any associated review fees, and certify completed projects as meeting the requirements of the program.

It is important to recognize that this only allows a CLG to review residential state tax credits, not commercial tax credits. Because the 2014 commercial tax credit program draws from a limited pool of available funding, state law requires that all applications for the commercial credit be processed by the Colorado Department of

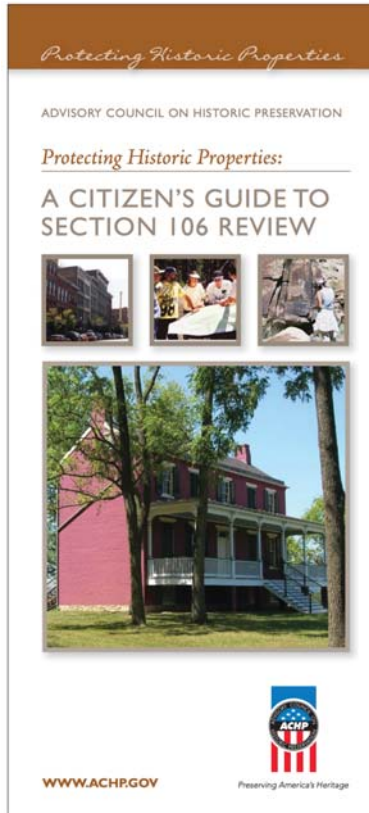

Economic Development and International Trade (OEDIT). Therefore, CLGs only have the authority to review applications for residential properties.

Section 106 Review

CLGs can play an important role in the Section 106 review process, which is the part of the National Historic Preservation Act of 1966 requiring federal agencies to consult with other parties to gauge whether a proposed undertaking (of which the federal agency is funding or issuing a permit for) will have an effect on historical, cultural and/or archaeological resources, and what alternatives might be needed to avoid or mitigate possible adverse effects on those resources. The federal agency may use an internal qualified staff member or hire a private outside company to do the background work for the Section 106 review process, but in either case is required to meet a series of conditions to proceed.

The federal agency is required by Section 106 to notify the local jurisdiction and offer an opportunity for comments, which in many cases will simply be a letter. The CLG's preservation commission can request that they be notified by the county or municipality administration when a notification is received. This allows the Commission to participate in this process by providing information on historic properties and districts, and by hosting an additional public forum for interested residents and neighborhood organizations to learn more information, ask questions, and express their views or concerns. To learn more about the Section 106 review process, visit <http://www.achp.gov/docs/CitizenGuide.pdf>.

CHAPTER 8: FREQUENT DESIGN CHALLENGES

While the community’s design guidelines will provide clear policy on most topics, there may be some that are more recent or may be ones in which new information has come forward. Others are topics that raise theoretical issues that call for a more in-depth discussion.

Extensive information exists about many of these new issues and technologies, and more continues to be published, so it is important that commissioners be open to new information as it becomes available. This chapter provides an overview to some of the “hot topics” that may arise in design review.

In This Chapter:

- A. Substitute Materials
- B. Sustainability and “Green” Issues
- C. Windows in Historic Buildings
- D. New Additions to Historic Buildings
- E. New Construction in Historic Districts



INFO ON SUBSTITUTE MATERIALS:

An excellent start for understanding the specifics of alternative materials is published by the National Park Service:

Preservation Brief 16, The Use of Substitute Materials on Historic Building Exteriors

See: <https://www.nps.gov/tps/how-to-preserve/briefs/16-substitute-materials.htm>

Note that, for projects seeking state or federal tax credits or other approvals, the SHPO or the National Park Service may apply a stricter standard for replacement materials. Local commissions should be aware of this when also reviewing these projects.

A. Substitute Materials

What are substitute materials?

In historic preservation, a substitute material is one that is used to appear similar to the original historic material. Today, this may mean using a cast concrete product to imitate a stone window sill.

Historians will point out, however, that the tradition of using substitutes goes back for centuries and that many of the materials we now consider historic were in fact alternatives to other materials that may have been more expensive or difficult to acquire.

A stamped metal cornice, at the top of an Italianate commercial building, for example, evolved from stone versions employed during the Renaissance in Europe. But, while there is precedent for their use, what is their appropriate application in rehabilitation projects?

Are substitutes appropriate at all?

In its publication, *Preservation Brief 16, The Use of Substitute Materials on Historic Building Exteriors*, the National Park Service acknowledges that substitute materials may be appropriate in some situations:

“Some preservationists advocate that substitute materials should be avoided in all but the most limited cases. The fact is, however, that substitute materials are being used more frequently than ever in preservation projects, and in many cases with positive results. They can be cost-effective, can permit the accurate visual duplication of historic materials, and last a reasonable time. Growing evidence indicates that with proper planning, careful specifications and supervision, substitute materials can be used successfully in the process of restoring the visual appearance of historic resources.”

Are substitutes always best?

Not necessarily. While claims for durability and accuracy of appearance may be made, the results don't always measure up. It is reasonable for commissions to ask to see examples of how the material has fared in similar environmental conditions and locations on properties.

Covering vs. replacing

Remember to confine the discussion about alternative materials to situations in which a replacement is indeed needed. That is to say, COVERING original material is not appropriate, regardless of what the new material would be. Removing original material that is in good condition and continues to serve its function is also inappropriate.

Reasons for considering alternative materials

If replacement is merited because of the severe deterioration of the original fabric, then doing so with the same material as the original is certainly preferred, but when might it be reasonable to consider an alternative? These are some conditions:

Inherent flaws in the original

In some cases, while the original material has historic value, it has not performed well and replacing in kind may perpetuate a problem. This is becoming more of an issue with some "Recent Past" resources from the mid-twentieth century, in which experiments with new materials and assembly methods sometimes led to disappointing results.

Availability of the original as replacement

If it is difficult to obtain the original material, then an alternative may be more acceptable.

Availability of craftsmen

Even if the original material may be available, are craftsmen on hand who can appropriately finish and install it? This may be an opportunity to sponsor a training program to build the local capability for such skills.

Code requirements

Contemporary building codes and related regulations may prohibit use of the original material. While this issue

MORE ON SUBSTITUTE MATERIALS:

The National Alliance of Preservation Commissions has published a helpful paper on alternative materials titled "Developing a Materials Evaluation Methodology." To read the full publication, visit:

See: http://napcommissions.org/wp-content/uploads/2013/08/Sustainability_Developing-A-Materials-Evaluation-Methodology-Part-1-2.pdf



This glass enclosure is a non-invasive strategy for a weatherization improvement. It captures winter heat on a front porch, while retaining the building's historic character and materials.



Original energy saving building features and systems, such as these operable shutters, should be maintained in good operating condition.

may apply more frequently to interiors, it may also be an issue for exterior features as well. Asbestos shingles and lead-based finishes are examples.

Costs

The use of alternative materials can many times be more cost-effective than replacing in-kind. Consideration regarding the area of the country, the amount of material needed, and the projected life of less durable substitute materials, in relation to cost, are all essential when considering alternative materials.

Criteria for alternative materials

If it is determined that using the original material may not be the best solution, what would be the criteria for considering an alternative replacement material? These are some conditions to consider:

Accuracy

Will the alternative material successfully convey an appearance that matches the original? They should be similar in:

- Detail
- Profile
- Texture
- Finish

Durability

Does the material have a satisfactory record of performance in a similar condition, including climate and location on the building? Experimenting on historic buildings is not the place to test new materials in the community.

Location on the property

Does the location on the property affect one's perception of the material? For example, a synthetic, resin-cast material may work well for a cornice molding that is located high on a building where it cannot be touched. By contrast, using this material for a replacement column on an entry porch where people will frequently touch it may not be suitable. Using alternatives on secondary walls, especially those not visible from the public way, may also be an option.

Impact on existing materials

Some new materials may interact negatively with other historic materials and accelerate deterioration. Combining some different metals, for example, can create a corrosive condition.

Extent of the replacement

A somewhat separate consideration is how extensive the need is to replace original materials, in terms of maintaining the integrity of the historic property. Replacing a single cornice with a substitute may have little effect. Wholesale replacement of all stone sills, window arches, moldings and foundations with cast concrete could threaten the historic significance of the property.

Addressing alternative materials in the design guidelines

Design guidelines should be as clear as possible about the use of alternative materials. If alternative materials are permitted, a discussion about appropriate locations should be integrated into the document; otherwise, creating a supplemental chapter or policy paper is an option.



Use building materials that appear similar in scale, color, texture and finish to those seen historically in the district.

Typical Materials

Typical historic building materials used in Old Town Fort Collins include:

- » Masonry
 - › Brick
 - › Stone
 - › Terra Cotta
 - › Poured Concrete
 - › Pre-cast Concrete
- » Wood
- » Metal
 - › Cast iron,
 - › Copper
 - › Sheet metal

Understanding the character of these materials and the patterns they create is essential to developing new interpretations.

Using New Materials

Compatibility with historic materials can be achieved without purely replicating their traditional use. A new building material that conveys the essence of modularity and the texture and finish of historic masonry, and that has proven durability in the local climate, is often compatible.

The degree to which an alternative material may be used successfully on a new building also will be influenced by the degree of consistency or variety in materials that already exists in the block.

MATERIALS

Traditional building materials in the historic district include various types of masonry, primarily brick, stone and concrete. Today, these materials are key to the character of the district.

Building materials shall reflect the range of textures, modularity and finish of those employed traditionally. They also shall contribute to the visual continuity of the specific historic district. They shall be of proven durability in similar applications.

5.14 Use building materials that appear similar in scale, color, texture and finish to those seen historically in the district.

- › Use materials that are proven to be durable in the local climate.
- › Use materials that will maintain an intended finish over time, or acquire a patina.
- › Use masonry with a modular dimension similar to typical masonry materials.
- › When an alternative material is permitted, use a durable material. (See "Using New Materials" to the left for more information.)
- › On the ground level, use materials that will withstand on-going contact with the public, sustaining impacts without compromising their appearance.

The use of alternative materials is addressed in the Old Town Historic District Design Standards for Fort Collins. Here it is addressed as a single topic, but the discussion continues throughout the document in other topics such as windows and doors.

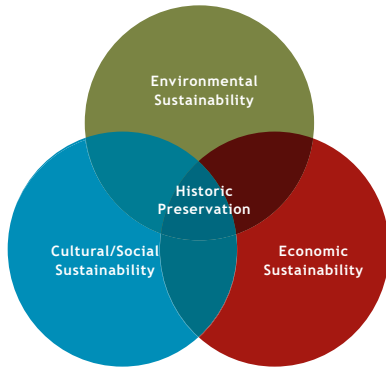

Preserving historic places promotes the three basic categories of sustainability.



The porch on this home helps to buffer temperature swings.

SOLAR PANEL DESIGN OPTIONS:

For a quick summary of solar panel design options, see the NAPC publication, “Sample Guidelines for Solar Systems in Historic Districts”: <https://www.growsolar.org/wp-content/uploads/2015/08/Sample-Guidelines-for-Solar-Systems-in-Historic-Districts.pdf>

B. Sustainability and “Green” Issues

Achieving energy efficiency and promoting sustainability and green building are major issues that commissions are now addressing. These issues are not new, but perhaps the level of activity and interest is heightened.

Does energy conservation “trump” preservation, or are the two mutually achievable? Design guidelines lack clear direction about how to balance green building objectives with the charge of protecting cultural resources. The basic principles of most guidelines call for preserving original materials and other character-defining features as well as respecting the inherent energy-saving properties of historic resources, but they usually address sustainability indirectly, particularly with respect to the way in which “building green” is seen today.

What is sustainability?

Sustainability is widely recognized as having three components:

- (1) cultural/social,
- (2) economic, and
- (3) environmental.

Historic preservation contributes to all of these, and to some extent all three may be addressed in design guidelines. This is because sustainability is a more global value underlying historic preservation, although it may not be so clearly articulated in some preservation ordinances and design guidelines.

Key concepts

As with the issue of substitute materials, the theory of sustainability and its related technologies continues to evolve. Consider these factors:

Keep the big picture

First, it is important to keep the big picture in mind. Don't become absorbed with evaluating the merits of a specific energy-saving device and its impacts on a historic property without first understanding how it fits into an overall energy strategy for the property.

Resource conservation

Preserving historic buildings and their materials avoids negative impacts from new construction. New building construction requires a tremendous amount of fossil fuels and other natural resources, which release greenhouse gases into the atmosphere and cause other negative effects. Replacing new windows rather than repairing historic windows, for example, can be extremely expensive. Retrofitting windows instead extends the life of the existing windows, avoids the production of newer materials, reduces waste and preserves a home's character. For more information regarding resource conservation for windows and other materials, see a listing of Preservation Briefs on the National Park Service website at <https://www.nps.gov/tps/how-to-preserve/briefs.htm> (i.e., 3 Improving Energy Efficiency in Historic Buildings; 9 The Repair of Historic Wooden Windows; and #13 The Repair and Thermal Upgrading of Historic Steel Windows). Also see Preservation Tech Notes at www.nps.gov/tps/how-to-preserve/tech-notes.htm.

Landfill reduction

Preserving a building reduces the amount of discarded building material that ends up in landfills.



Double-Hung Window Ventilation

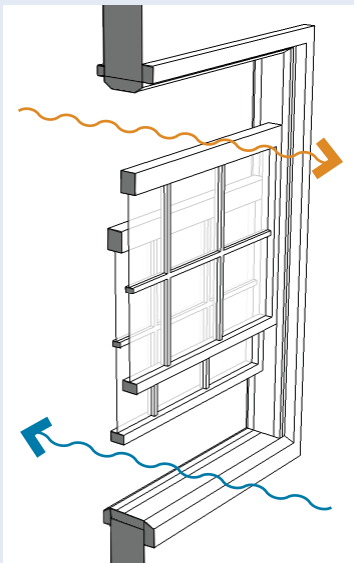

The double hung windows found in many historic structures allow for transferring cool air in and warm air out during summer months.

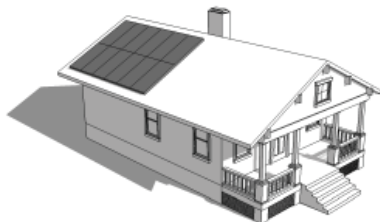

Locating solar panels and energy generating devices to the rear of a historic residence minimizes visual impacts.

Life cycle analysis

When considering the life cycle of building materials, one must consider the energy consumed to create the materials, but also environmental costs, such as resource depletion and pollution. These ideas may be difficult to convey, but it is important to set out these concepts as a foundation for the guidelines. Comparing these “costs” to the longevity of the material is key to life cycle analysis. Often more traditional materials will score the highest, because they will last longer and have less pollution associated with their manufacture, in contrast to some newer materials that may appear cost-effective early on, but are not as durable over time. Some synthetic materials used in windows are often cited as examples.

Typically a commission will not directly evaluate the life cycle performance of materials that are proposed for alterations, but the technical information related to this topic can assist property owners in developing a strategy for sustainability. It also will underpin reasoning to retain older, significant materials that do have longer life cycles than some replacements will.

Energy conservation

Reducing energy consumption for a property is a key objective for many property owners, and should be addressed in the design guidelines. Often, sealing leaks and adding insulation to ceilings and floors will be the most effective.

Energy generation

The companion piece to energy conservation is energy generation, in the interest of reducing demand on public utilities and minimizing operating costs. Examples of energy generation methods include solar panels and wind turbines. Since property owners may be immediately attracted to these two approaches, they should be placed in context with other elements of sustainability in the introductory materials.

Developing a strategy for a property

A property owner should outline an overall strategy for energy conservation and generation as it relates to their property. This strategy should include an energy audit, an evaluation of existing systems, and a list of established goals for achieving savings. Several good publications, such as the National Park Service’s “Improving Energy Efficiency in Historic Buildings” and Maine Preservation’s “Guidelines for Improving Energy Efficiency in Historic Buildings,” describe how to prepare a strategy for older buildings. The aforementioned documents can be found at <https://www.nps.gov/tps/how-to-preserve/briefs/3-improve-energy-efficiency.htm> and <http://mainepreservation.org/preservation-help/for-homeowners/guidelines-improving-energy-efficiency-historic-buildings>.

Here are some basic steps to suggest to property owners in preparing a strategy:

Conduct an energy audit.

An energy audit often reveals a number of opportunities to reduce energy consumption.

Set project goals for sustainability.

Setting goals will help place individual actions into context, and may, for example, demonstrate that priorities for energy conservation should be to increase insulation in walls, ceilings, and foundations rather than replacing windows.

Identify management opportunities.

Management strategies for energy conservation (such as raising and lowering awnings to adjust temperatures, or using a ceiling fan to de-stratify air) should also be used.

Develop an overall strategy for the property.

When a property owner can present a strategy as a part of their application for a Certificate of Appropriateness, it also can help the commission consider the potential benefits of the actions proposed. If the strategy contains audit findings, this information may help place a specific request, such as window replacement, into context in terms of payback of investment.

GUIDELINES FOR COMMISSIONS:

The National Trust for Historic Preservation has published a booklet of advice for commissions considering writing guidelines for sustainability called *Developing Sustainability Guidelines for Historic Districts*.

See: <http://www.amazon.com/Developing-Sustainability-Guidelines-Historic-Districts/dp/0891333991>

NATIONAL TRUST'S SUSTAINABILITY PROGRAM:

The National Trust for Historic Preservation's sustainability work is focused on finding federal, state and local policy solutions that level the playing field for older buildings and enable people to save and improve the energy performance of the places they care about. The National Trust is working through the Seattle-based Preservation Green Lab with national partners to pioneer new policy solutions that will ensure historic buildings can remain vital parts of sustainable communities across the country.

The National Trust's sustainability program website offers information that is useful to commissions on everything from retrofitting your wood windows to the latest information from the Preservation Green Lab and Capitol Hill.

Basic principles for sustainability and preservation

The following principles should apply to all projects:

Think big, act small.

When planning any project, first determine the overall goal, and then consider which method of achieving that goal will use the fewest resources and have the least impact to the historic structure.

For example, a comprehensive approach will usually demonstrate that replacing windows is not an effective conservation strategy.

Make best use of inherent conservation features.

Make best use of a building's inherent sustainability features as a first step.

For example, use awnings to moderate temperatures.

Minimize negative impacts on the historic resource when installing a new component.

It is important that new components should leave no permanent negative impacts to the structure. Locate a new component where it will not damage, obscure, or remove significant features or materials. Maintain the ability to interpret the historic character of a building when retrofitting for energy conservation or generation.

For example, locate a solar collector to be visually unobtrusive.

Use materials that minimize environmental impacts in their manufacture and maintenance.

Such materials include those that are produced locally, are manufactured without use of harsh chemicals, have long life cycles, are durable in the local climate and are designed to be repairable and recyclable.

For example, some vinyl windows may use harsh chemicals and have short life cycles and are difficult to repair.

Use construction methods that minimize impacts on landfill and reduce waste.

Preserving as many existing building features as possible reduces demolition waste, and reduces construction waste generated by replacement building materials. Remove only what is necessary and reuse as much material as feasible on-site. Repurpose as much of the remaining building materials and components as possible to minimize waste and demand for landfill space.

For example, avoid sending original windows to the landfill.



THE SECRETARY OF THE INTERIOR'S STANDARDS AND GUIDELINES FOR SUSTAINABILITY:

Published in 2011, these supplement the SOI's Rehabilitation Standards, addressing energy conservation techniques in detail.

See: <https://www.nps.gov/tps/standards/rehabilitation/sustainability-guidelines.pdf>



Commercial Building Efficiency Diagram

This diagram summarizes the principal direction for a rehabilitation project for energy efficiency on a commercial building. These measures can enhance energy efficiency while retaining the integrity of the historic structure.

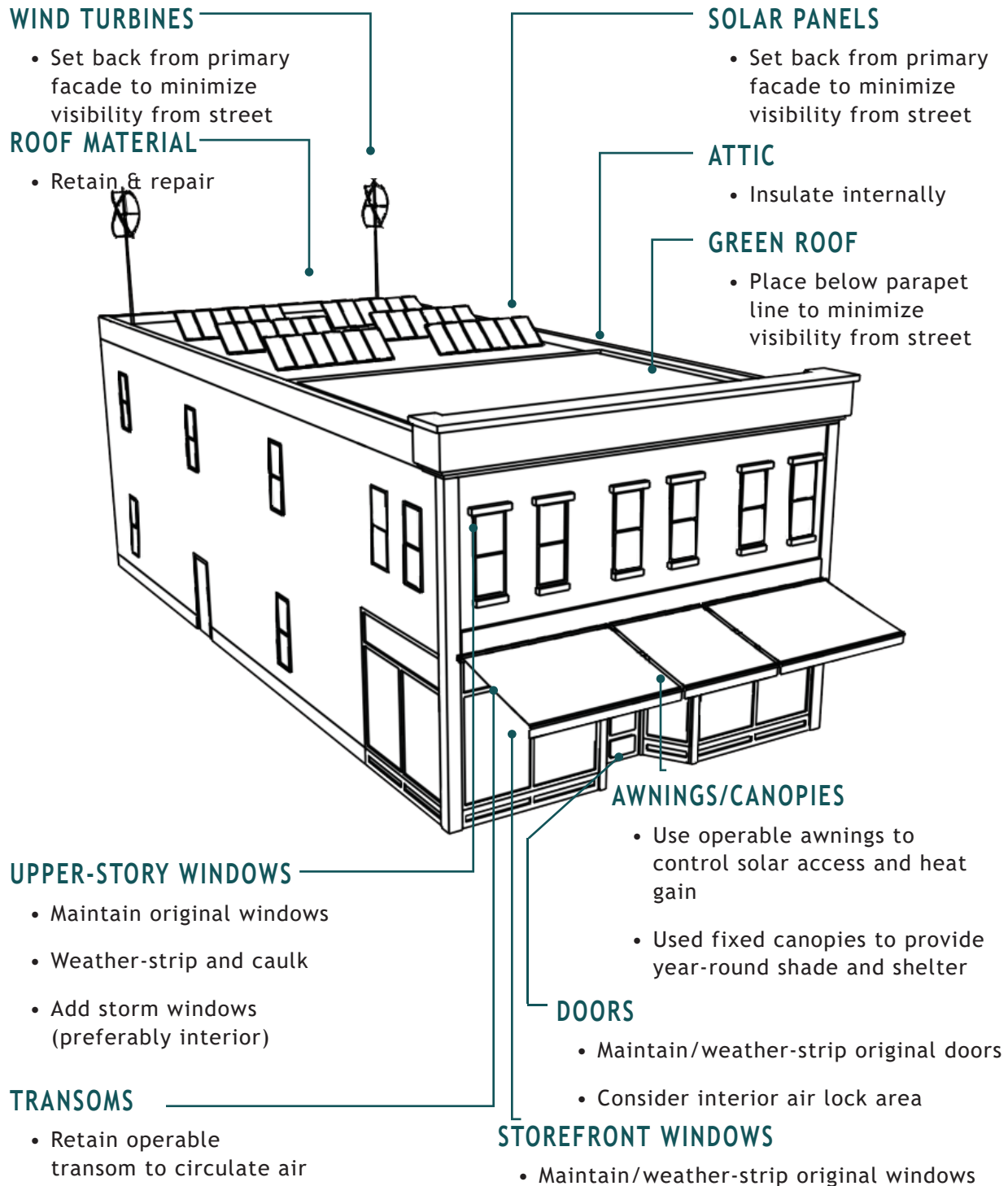

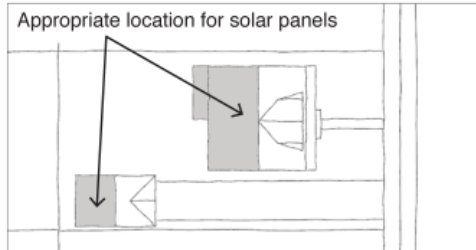
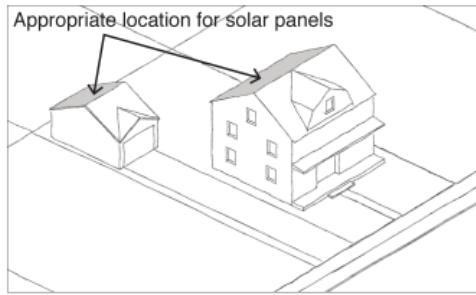

Guideline 9.1: Solar panels should be located to the side or rear roof planes or on a secondary structure (all gray surfaces).

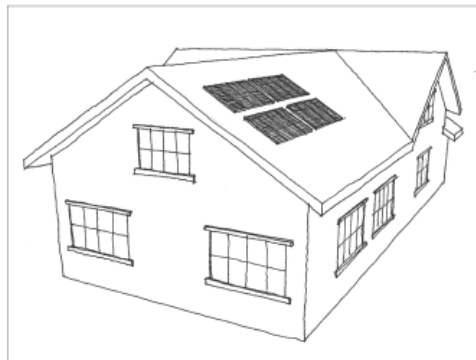

Guideline 9.1: Solar panels should be mounted flush with the roof.

9.0 SOLAR PANELS

Solar panels should be located in unobtrusive places. If it is necessary to mount solar panels on a historic building, rather than elsewhere on the site, it is essential that the panels are installed such that they do not change the character of the building. If solar panels are placed on a roof they should be designed and positioned to have a minimal effect on the character of the structure. Placement on rear facing roof planes of the primary structure should be considered first.

Design Objective

Solar panels should not adversely affect the historic character of the structure to which they are being added.

9.1 Reduce the visual impacts of solar panels as seen from the public right-of-way.

- Locate the solar panels away from public view when feasible.
- Solar panels should be mounted apart from the building or on secondary structures, such as a shed or garage, when feasible.
- Solar panels should be located on new construction, such as a new wing, where possible.
- Locate an attached solar panel in a manner such that it does not affect the primary roof facade elevations.
- Location on a primary or street facing roof plane is generally inappropriate.
- Where roof mounted, solar panels should be flush to the extent feasible.
- If not attached to the building, collectors should be located in side or rear yards. Exposed hardware, frames and piping should have a matte finish, and be consistent with the color scheme of the primary structure.
- Panels not attached to the building should be screened by landscaping to reduce their visibility. However, screening may diminish the effectiveness of the collectors to receive sunlight.
- Alternative technologies, such as photovoltaic shingles, may be appropriate in certain circumstances.

Preservation guidelines for Montgomery County, MD recommend that solar panels be located on secondary structures or subordinate portions of the primary buildings, when feasible. Some other communities are more flexible, providing guidance about design details of the panels on a primary elevation. Still other commissions take a stricter position, prohibiting them when visible from the public way.

INFO ON WINDOWS:

The National Alliance of Preservation Commissions has published several helpful papers on windows and energy savings.

Publications include <http://napcommissions.org/wp-content/uploads/2013/08/what-replacement-windows-cant-replace.pdf>

“What Replacement Windows Can’t Replace: The Real Cost of Removing Historic Windows”: Replacement window manufacturers will often compare their product to a historic wood window that has not been restored or maintained - a window that fits this description will undoubtedly be drafty and inefficient. In most cases, however, a fully-restored, tight-fitting, properly functioning, weather-stripped wood window combined with a quality storm window will have the same insulating properties as a double-glazed replacement window. Other steps can be taken to reduce heating bills, such as insulating attics and floors; the U.S. Department of Energy notes that 31% of air infiltration is at floors, walls, and ceilings, and only 10% at windows.

C. Windows in Historic Buildings

Replacing windows

One challenge that commissions face is how to respond to a request to remove an existing historic window and replace it with a new one. This raises questions about the significance of the window, its condition, and the character of the proposed replacement. This can be a highly charged conversation, with the debate all too frequently jumping to the merits of the proposed replacement rather than first determining if replacement is necessary at all.

Windows are some of the most important character-defining features of most historic structures. They give scale to buildings and provide visual interest to the composition of individual facades. Distinct window designs in fact help define many historic building styles. Because windows so significantly affect the character of a historic structure, the treatment of a historic window and the design of a new one are therefore very important considerations.

Window features

The size, shape and proportions of a historic window are among its essential features. Another important feature is the number of “lights,” or panes, into which a window is divided. The design of surrounding window casings, the depth and profile of window sash elements and the materials of which they were constructed are also important features. Early windows in Colorado were made of wood but metal casement windows also were popular, particularly on industrial buildings and in later Modernist styles. In either case, they had distinct dimensions, profiles and finishes. These are important considerations for commissioners when evaluating an existing window and any potential replacement.

Deterioration of historic windows

Properly maintained, original windows will provide excellent service for centuries. Most problems that occur result from a lack of maintenance. Water damage and the ultra violet degradation caused by sunlight also are

major concerns. If surfaces fail to drain properly, water may be introduced. Condensation during winter months also can cause problems.

Repair of historic windows

As with other historic features, preservation in place is the preferred approach. Whenever possible, a historic window should be repaired, rather than replaced. In most cases it is in fact easier, and more economical, to repair an existing window rather than to replace it. Even when replaced with an exact duplicate, a portion of the historic building fabric is lost and therefore such treatment should be avoided.

When is replacement appropriate?

When considering whether to repair or replace a historic window, commissioners should consider the following:

First, determine the window's architectural significance.

Is it a key character-defining element of the building? Typically, windows on the front of the building and on sides designed to be visible from the street, are key character-defining elements. A window in an obscure location, or on the rear of a structure may not be. Greater flexibility in the treatment or replacement of such secondary windows may be considered. Also, in some cases, the window in question may be a more recent alteration and therefore will lack significance.

Second, inspect the window to determine its condition.

Distinguish superficial signs of deterioration from actual failure of window components. Peeling paint and dried wood, for example, are serious problems, but often do not indicate that a window is beyond repair. A rotted sill may dictate its replacement, but it does not indicate the need for an entire new window. Determining window condition must occur on a case-by-case basis; however as a general rule, a window merits preservation, with perhaps selective replacement of components, when more than 50 percent of the window components can be repaired.

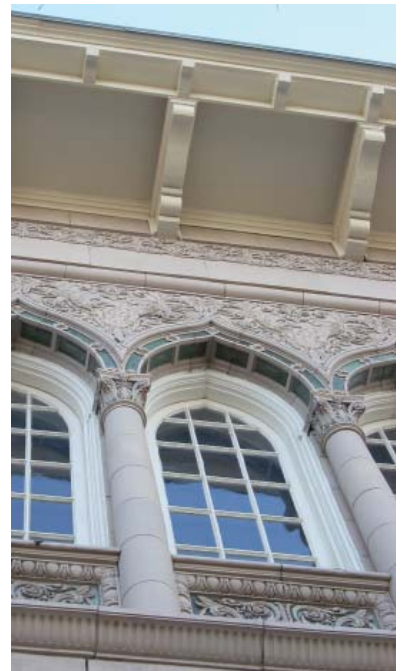



Commissioners may ask for a window-by-window survey of a property, rather than considering an all-or-nothing approach to a replacement request.

Third, determine the appropriate treatment for the window.

Surfaces may require cleaning and patching. Some components may be deteriorated beyond repair. Patching and splicing in new material for only those portions that are decayed should be considered in such a case, rather than replacing the entire window. If the entire window must be replaced, the new one should match the original in appearance.

Energy conservation

In some cases, owners may be concerned that an older window is less efficient in terms of energy conservation. In winter, for example, heat loss associated with an older window may make a room uncomfortable and increase heating costs. In fact, most heat loss is associated with air leakage through gaps in an older window that are the result of a lack of maintenance, rather than loss of energy through the single pane of glass found in historic windows. Glazing compound may be cracked or missing, allowing air to move around the glass. Sash members also may have shifted, leaving a gap for heat loss.

The most cost-effective energy conservation measures for most historic windows are to replace glazing compound, repair wood members and install weather stripping. These steps will dramatically reduce heat loss while preserving historic features.

If additional energy savings are a concern, consider installing a storm window. This may be applied to the interior or the exterior of the window. It should be designed to match the historic window divisions such that the exterior appearance of the original window is not obscured.

Replacement windows

While replacing an entire window assembly is discouraged, it will be necessary in some cases. When a window is to be replaced, the new one should match the appearance

of the original to the greatest extent possible. To do so, the size and proportion of window elements, including glass and sash components, should match the original. In most cases, the original profile, or outline of the sash components, should be the same as the original. At a minimum, the replacement components should match the original in dimension and profile and the original depth of the window opening should be maintained.

A frequent concern is what the material of the replacement window should be. While wood was most often used historically, metal and vinyl clad windows are common on the market today and sometimes are suggested as replacement options by window suppliers. In general, using the same material as the original is preferred by most preservationists. If the historic window was wood, then using a wood replacement is the best approach, especially in highly visible locations. However, some commissions will consider permitting alternative materials if the resulting appearance will match that of the original, in terms of the finish and the profile of sash members. The substitute material also should have a demonstrated durability in similar applications in this climate.

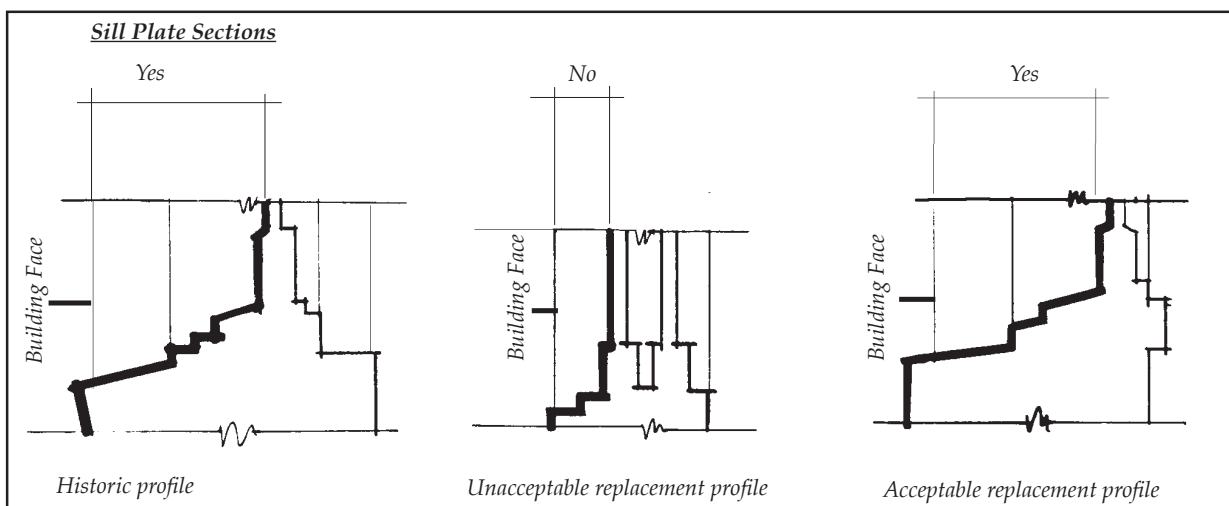

When replacing a historic window, match the profile of the sash and its components, as closely as possible to that of the original window.

Replacing Windows

General Rehabilitation Design Guidelines

Resource Category	Historic Resource with Historic Window	Historic Resource with Non-Historic Windows	New Additions	Accessory Structures/Out Buildings: Historic	Accessory Structures: Non Historic or New Construction
Master Plan Site	Primary Elevation: Repair historic windows; if beyond repair, wood TDL	Primary Elevation: Wood TDL appropriate for resource type/style	Visible from Public Right of Way (PRW): Wood TDL appropriate for resource type/style	With historic windows: Repair historic windows; if beyond repair, wood TDL	Wood SDL appropriate for resource type/style
	Secondary Elevation: Repair historic windows; if beyond repair, wood TDL	Secondary Elevation: Wood TDL appropriate for resource type/style	Not visible from PRW: Wood SDL appropriate for resource type/style	Nonhistoric Windows: Wood SDL appropriate for resource type/style	
Outstanding	Primary Elevation: Repair historic windows; if beyond repair, wood TDL	Primary Elevation: Wood TDL appropriate for resource type/style	Visible from Public Right of Way (PRW): Wood TDL appropriate for resource type/style	With historic windows: Repair historic windows; if beyond repair, wood TDL	Wood SDL appropriate for resource type/style
	Secondary Elevation: Repair historic windows; if beyond repair, wood TDL	Secondary Elevation: Wood TDL appropriate for resource type/style	Not visible from PRW: Wood SDL appropriate for resource type/style	Nonhistoric Windows: Wood SDL appropriate for resource type/style	
Contributing	Primary Elevation: Repair historic windows; if beyond repair, wood TDL	Primary Elevation: Wood SDL appropriate for resource type/style	Visible from Public Right of Way (PRW): Wood SDL appropriate for resource type/style	With historic windows: Wood SDL appropriate for resource type/style	Wood SDL appropriate for resource type/style
	Secondary Elevation: Repair historic windows; if beyond repair, wood TDL	Secondary Elevation: Wood SDL appropriate for resource type/style	Not visible from PRW: Wood SDL appropriate for resource type/style	Nonhistoric Windows: Wood SDL appropriate for resource type/style	
Non Contributing	No restrictions for primary or secondary elevations			No restrictions on existing nonhistoric or new accessory structures, whether they are visible or not visible from PRW	
Infill/New Construction on Master Plan Site or District	Primary structure: Wood SDL appropriate for resource type/style			Accessory Structures: Wood SDL appropriate for type/style	

These are minimum standards. The majority of projects subject to HPC review involve light wood frame construction, which traditionally had wood windows. The window guidance above is specific to these types of resources. Other types of resources may traditionally have used windows constructed of materials other than wood, and in those cases the use of other window materials may be appropriate. Contact County staff for interpretation of rating a Resource Category.

- TDL: *True Divided Light*
- SDL: *Simulated Divided Light*

Design guidelines for Montgomery County, MD provide more detailed guidance about replacement windows in general, which can also apply to energy efficiency retrofit questions. The guidelines remain more strict about replacements on primary walls and on contributing structures.

D. New Additions to Historic Buildings

Commissions often struggle with proposals to construct additions to historic buildings. Adding on is certainly a part of our heritage, and it can signify good things relevant to preservation: A desire to continue the life of an existing building, a healthy economy and a vital neighborhood. As such it can be a part of accommodating change while preserving the integrity of historic resources. In reviewing a proposal for an addition, it is important to evaluate it in an orderly informed manner. Be careful not to jump to a single issue, such as size or style, without considering more fundamental aspects of the design first.

Different types of additions may be proposed:

First is a ground level addition, which involves expanding the footprint of the structure. This is often located to the rear of the primary building, but sometimes is to the side. Secondly, a rooftop addition may be proposed. On a house, this may involve constructing a new dormer to provide more headroom in an attic space. For commercial buildings, a rooftop addition may be added, often set back from the front wall.

Key principles for additions are:

Minimize negative effects on historic building fabric.

When planning an addition to a historic building or structure, one should minimize negative effects that may occur to the historic building fabric as well as to its character. While some destruction of historic materials is almost always a part of constructing an addition, such loss should be minimized.

Maintain the ability to perceive the historic character of the main building.

The addition also should not affect the perceived character of the building. In most cases, loss of character can be avoided by locating back away from the front of the building. The overall design of the addition also must be in keeping with the design character of the historic structure. Most preservationists advocate a design

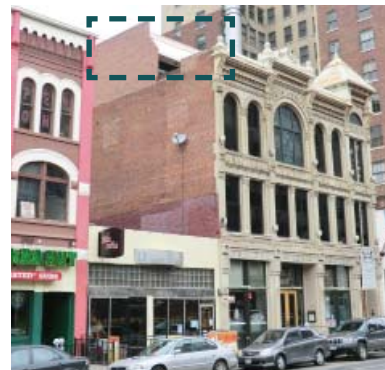

The additions shown in the pictures above display appropriate placing of new features. The fourth-story addition in the top photo is set back from the street, and therefore has low visibility from public views. The addition in the bottom photo shows a modern fire escape placed on the back of a historic building, which is also an appropriate place for an addition.



This photo also shows an appropriate addition where the roofline is altered but is not very visible from the public right of way.

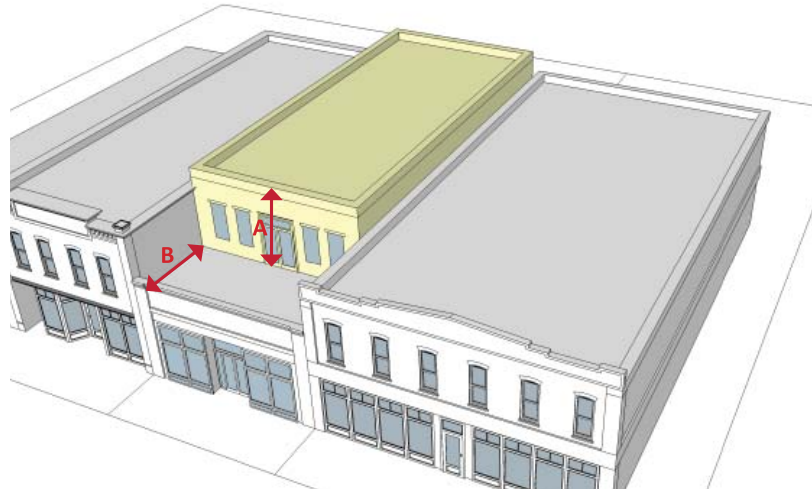

Rooftop addition is appropriate in that it is set back from the main facade and is only one-story high, meaning it is not very visible from the public right of way.

that is distinguishable, albeit in subtle ways, from the historic portion, such that the evolution of the building can be understood. It is also important that an addition not obscure significant features of the historic building. Keeping the design subordinate in character also helps minimize its visual impacts. That is, the design should avoid calling attention to itself with highly ornate details or exotic forms.

Maintain the ability to interpret the character of the district.

In a historic district, the commission also should consider the effect that the addition may have on the character of the area. For example, a side addition may change the sense of rhythm established by side yards in a residential block if it is too large or is located too close to the front wall of a house in a row of single family structures.

IMPACT CONSIDERATIONS FOR AN ADDITION

Impact considerations address the visual and physical impacts of the addition on the integrity of the property, and one's ability to perceive its historic character, as well as that of its context.

Some impact-related factors to consider include:

- » The impact on the historic structure
 - a. Is the addition visible?
 - b. Does the addition remain visually subordinate to the historic structure?
 - c. Is one's ability to interpret the historic character retained? (Especially in terms of perceiving the original mass, scale and prominence of the property)
 - d. Are alterations to key character-defining features avoided or at least minimized?
 - e. Is the structural integrity of the property retained, or even improved?
- » The impact on the abutting contributing properties
 - a. Is one's ability to interpret the historic character of the abutting properties retained? (Especially in terms of perceiving their original mass, scale and relative prominence on the street or from other public vantage points?)
- » The impact on the block as a whole
 - a. Are the rhythm and alignment of structures and their key features typical of the block retained?
 - b. Is the perception of the scale of structures along the block retained, as experienced at the street level?
 - c. If the character of an alley wall is also a key feature, is its scale also retained?

DESIGN VARIABLES FOR AN ADDITION

Design variables include basic scale and proportion considerations that relate to the compatibility of the addition with the primary structure and surrounding historic context.

Design variables to consider include:

- » The height of the addition.
Keeping floor heights in the range of those on the historic structure, or even lower, may help keep an addition visually subordinate to the historic structure.
- » The degree of setback.
Does the original primary façade (front) remain visually prominent? An addition should be set back from the façade and other key walls that contribute to the character of the property. The setback should be a sufficient distance such that the historic structure remains prominent.
- » Simplicity of design.
Is the design of the addition subordinate in character? The design should be relatively simple in architectural character and detailing, such that it does not call undue attention to itself. The historic structure should remain the prominent feature.

PRESERVATION BRIEF 14: NEW EXTERIOR ADDITIONS TO HISTORIC BUILDINGS PRESERVATION CONCERNS

Technical Preservation Services, National Park Service.

This preservation brief provides guidance on new additions, compatible additions to historic buildings, revising incompatible designs, incompatible new additions, new additions in densely-built environments, rooftop additions and designing a new exterior addition. References and reading lists of related materials can be found at the National Park Website:

<https://www.nps.gov/tps/how-to-preserve/briefs/14-exterior-additions.htm>

APPROPRIATE SETBACKS OF ROOFTOP ADDITIONS ON COMMERCIAL BUILDINGS



E. New Construction in Historic Districts

Commissions often struggle with the question of what “style” should be permitted in a historic district. Should it be one that copies the historic buildings in the area? Or should it be distinguished as new?

Compatible but contemporary

The broadly held philosophy for new construction in a historic district is that it should be compatible with the historic setting without confusing the history and evolution of the area. This means that new buildings should reflect their own time and be distinguishable from their historic neighbors. At the same time, they should not contrast so jarringly as to inhibit one’s ability to interpret the historic character of the district. In this approach, overall character of the area is retained, while accommodating change. It has these features:

- The evolving character of the area is reflected.
- Historic resources, from all periods of significance, are preserved.
- Historic resources and other traditional buildings provide the context for new construction, in terms of form, materials, etc.
- New buildings express their true age, but are compatible with the historic context by drawing upon basic design relationships that are essential to the area.

This approach is preferred by historians. It reflects the evolving story of the district, while providing a compatible setting for the genuine historic resources that exist. It also permits flexibility in responding to changing markets and functional requirements. It is the one most widely used across the country and is consistent with the Secretary of the Interior’s Standards. In addition, it adapts well to areas that have several layers of history, different themes of development or many periods of significance.





In this approach, the design for a new building is based on basic features that are similar to those of historic structures, but the results do not literally mimic historic styles. The design is compatible in mass, scale and character but subtle differences in stylistic treatment make the building distinguishable as new construction. In this way, one can read the evolution and change of the district, while also retaining a visually compatible sense of time and place.

Defining the key, underlying features of the area is important, and basic neighborhood characteristics of mass, scale and materials must be respected in new construction, even though “contemporary” designs are allowed. Note that the term “contemporary” in this sense refers to the current period, not to a particular architectural style.

Historic references in new designs

While the “contemporary” approach is preferred by most communities, some also permit designs that are more imitative of historic styles. Because the new buildings copy the historic styles, one is generally assured that they will be visually compatible with their historic neighbors. However, this can be a “slippery slope,” in which poorly executed imitations may creep into the district. An oversize box, decorated with a few Victorian era brackets, does not guarantee compatibility!

A liability of this approach is that it can, to some extent, change the apparent history of the area and the physical record of the evolution of the street can be blurred. If development occurs that is similar in location, scale and character to that seen historically, at least a reasonably accurate story can be discerned. If, however, the new development is different in scale and siting from that seen historically, even though the styles appear to be from the period of significance, the message may be garbled. Most historians discourage this approach because it is deceiving. That said, commissions may often approve such designs. What is important is that the theoretical implications of the decision to do so are understood.

CHAPTER 9: INCENTIVES FOR PRESERVATION

While the benefits of preservation that are described in Chapter 1 in themselves are sound reasons for maintaining historic resources in good condition, many other incentives exist. Many of these are financial while some focus on providing technical assistance. These are presented in this chapter, organized in the different levels of government at which they may be offered. Only those that are used most frequently are described. A broader list of many of the programs that are available can be found under “fundraising” and “grants” at <http://www.preservenet.cornell.edu/links.php>

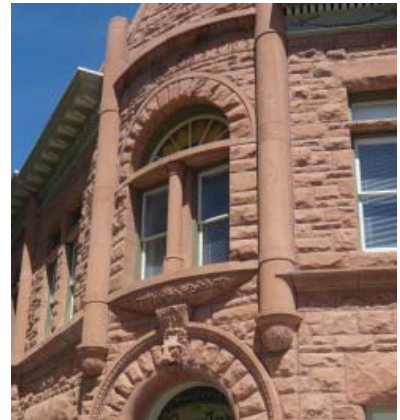

In This Chapter:

- A. Incentives for Preservation
- B. Resources That Can Help



A. Incentives for Preservation

Local preservation incentives

Many communities in Colorado may offer incentives for preservation of historic properties. Some of these are:

Sales tax rebate

Some communities offer a rebate on locally paid sales tax on materials used in an approved preservation project. An example is the City of Boulder, which offers a waiver of city sales tax on construction materials when applying for a building permit, if at least 30 percent of the value of materials is for the building's exterior.

Low interest & zero interest loan programs

Some communities offer special loan programs to promote rehabilitation. For example, Fort Collins provides 0% interest loan funds to residential and non-residential historic properties. Loan funds are repaid to the City only through the sale or transfer of the property. Funds returned to the City are recycled back into the program, providing an ongoing source of dollars for additional projects.

Exemptions and variances

Some local governments also offer exemptions to some local regulations. Variances for encroachments, including reconstruction of missing historic features are examples. Others may waive parking requirements or permit some uses that otherwise would not be allowed in the particular zone district. The City of Aspen has a variety of variances that the HPC may grant to designated properties to allow such exceptions as development in the side, rear and front setbacks and development that does not meet the minimum distance requirements between buildings.

Technical assistance

Some communities offer a small grant to assist in securing professional consultation related to historic buildings. The Design Assistance Program in Fort Collins is an example: Instituted by City Council in 2011, the Design Assistance Program aims to help property owners minimize the impacts of additions, alterations, and new

construction on neighbors and on the overall character of the historic Eastside and Westside Neighborhoods. Council recognized the usefulness of such a program as an educational solution for many of the problems with design compatibility in these areas. The program enables owners to utilize the expertise of qualified consultants with documented experience in compatible historic design, for new construction and alterations as well as for project planning. Approved consultants have demonstrated competency in promoting design compatibility within the historic context.

Easements

A historic preservation easement is a voluntary legal agreement, generally in the form of a deed, which permanently protects the character of a significant historic property. This easement is given from a property owner to an organization, which must be qualified to be the recipient of an easement, although it still allows a property owner to retain private ownership. The conservation easement then gives the organization the right to inspect the property to ensure that the owner is complying with the terms, which typically include maintaining the historic character of the building envelope, meaning that any maintenance work or alterations are subject to the approval of the easement holder. Easement donors also have the opportunity to receive federal tax benefits, as the easement counts as a charitable contribution. Many owners join this donation benefit with state and federal tax incentives for rehabilitation of certified historic properties. In the State of Colorado, the Colorado Historical Foundation and Historic Denver, Inc. are the largest preservation easement holders. To learn more about easements, consult the National Park Service Technical Preservation Services brief, “Easements to Protect Historic Properties”, which can be found at <https://www.nps.gov/tps/tax-incentives/taxdocs/easements-historic-properties.pdf>.





FOR MORE INFORMATION:

To find out more about specific residential and commercial tax credits, visit:

http://www.historycolorado.org/sites/default/files/files/OAHP/Programs/ITC_Residential.pdf

<https://choosecolorado.com/doing-business/incentives-financing/the-commercial-historic-preservation-tax-credit/>

Property tax rebate

Some communities throughout the state offer property tax rebates for historic structures. The City of Littleton has a great example of this rebate, in which individually listed landmarks in the city's Main Street District qualify for a refund of 100% of City of Littleton property taxes.

Local Rehabilitation Grant Programs

Many communities in Colorado offer grant programs to support the rehabilitation of historic properties. The City of Lafayette, for example, has a program that is run through the Historic Preservation Board that offers two competitive grants of \$1,000 for building improvement projects.

State of Colorado incentives

Colorado Historic Preservation Tax Credit

Enacted in 2014, the Colorado Job Creation and Main Street Revitalization Act expanded an earlier state tax credit program. Colorado is among more than 20 states with a state-level rehabilitation tax credit program. Originally established in 1991 and reauthorized in 1999 and 2008, the program allows a credit of 20% of approved rehabilitation on qualified properties, with a \$1,000,000 maximum credit allowable for commercial properties and \$50,000 for residential. The commercial credit is transferable, meaning that if an owner wishes, the credit can be transferred to another Colorado income tax payer. This transfer allows non-residents with no Colorado Income Tax Liability and non-profits who have no income tax liability to benefit by "transferring" tax credits through a sale of those credits. In order for a property that is locally listed to be eligible for the Colorado Historic Preservation Tax Credit, the local government must be a CLG. <https://www.historycolorado.org/preservation-tax-credit-fact-sheet>.

State Historical Fund

History Colorado's State Historical Fund grants program exemplifies how preservation efforts make a tangible difference in the quality of life in communities across Colorado. Funds are distributed through a competitive process and all projects must demonstrate strong public

benefit and community support. Grants vary in size, from a few thousand dollars to amounts up to of \$200,000. The Fund assists in a wide variety of preservation projects including restoration and rehabilitation of historic buildings, architectural assessments, archaeological excavations, designation and interpretation of historic places, preservation planning studies, and education and training programs. Grants are available to governmental entities and non-profits. Private owners may partner with a local government or non-profit and apply for a grant, if the privately owned property has a public benefit. For more information on the Grants programs offered through the State Historical Fund visit:

<https://www.historycolorado.org/state-historical-fund>

CLG Grants

History Colorado administers funds for the Department of the Interior and National Park Service, which has specified that at least 10% of Colorado's annual historic preservation funds be subgranted to CLGs. Since 2000, this requirement has been augmented with an internal grant from the State Historical Fund. A CLG community can apply for the grant with a variety of different types of projects including survey work, brochure creation, and training for historic preservation commissions or programs. No matching funds are required.

Colorado Main Street Program

With financial support from the State Historical Fund, the Colorado Main Street Program offers preservation architectural assistance to building and business owners within Main Street communities.

Revolving Loan Fund

The Colorado Historical Foundation (CHF) created the CHF Revolving Loan Fund (Loan Fund) to leverage resources available for preservation of Colorado's historic buildings. The Loan Fund partners with the State Historical Fund to provide low interest rate loans as an additional source of funding for historic preservation. For more information about the CHF Revolving Loan Fund visit: www.cohf.org.



FOR MORE INFORMATION:

In addition to CLG and Main Street grant programs, Main Street communities can access financial incentives including:

- non-competitive mini-grants and consulting services may be available for local Main Street communities and projects identified in their work plan
- conference scholarships to conferences hosted by organizations such as National Main Street Center, Colorado Preservation Inc. and Downtown Colorado, Inc.
- the Colorado Main Street Architect, who is able to help local government and private property owners upon request through the local Main Street Program

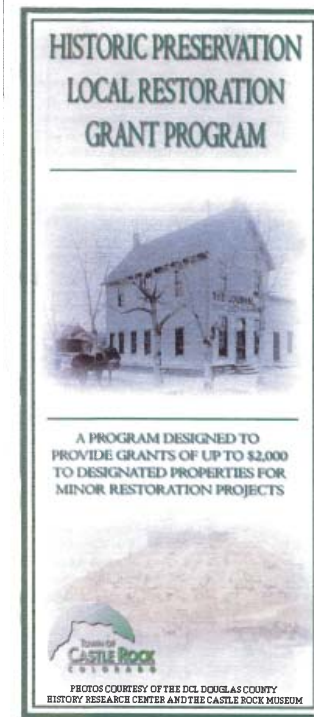

Federal incentive programs

Federal Income Tax Credit

The Federal Historic Preservation Tax Incentives Program offers a 20% tax credit for the rehabilitation of income-producing historic structures listed on the National Register. Rehabilitation of building constructed before 1936 that are not eligible for listing on the National Register qualify for a 10% tax credit. This program is administered by the National Park Service in partnership with the Internal Revenue Service and SHPOs. For more information, see <http://www.nps.gov/tps/tax-incentives.htm>.

Low-Income Housing Tax Credit

The Tax Reform Act of 1986 allows for the acquisition and rehabilitation of low-income housing by providing different levels of tax credit depending on the scope of the project and any other federal funding involved. Property owners have fifteen years to bring the project into compliance by making some or all units available on an income restricted basis. For more information visit: https://www.hud.gov/program_offices/fair_housing_equal_opplihctmou.

New Markets Tax Credits

The Community Development Financial Institution of the U.S. Department of the Treasury offers the New Markets Tax Credits incentive, as authorized by the Community Renewal Tax Relief Act of 2000. Thirty-nine percent credit is available for investment in Community Development Entities. For more information visit: <https://www.cdfifund.gov/programs-training/Programs/new-markets-tax-credit/Pages/default.aspx>

Other economic benefits

In addition to financial incentives that benefit property owners directly, many benefits of preservation extend to the community as a whole. These include:

Rehabilitation jobs and construction sales

Direct benefits to the local economy result from the actual purchases of labor and materials. Preservation projects are generally more labor intensive, with up to 70% of the total project budget being spent on labor, as

opposed to 50% when compared to new construction. This usually means that a higher percentage of the construction budget remains in the community.

Real estate values

Numerous studies across the country document the positive effects on real estate values in locally designated historic districts. Statistics consistently show that properties within historic districts match or exceed values in comparable, undesignated areas.

Heritage tourism

Heritage tourism engages visitors in places, artifacts and activities that authentically represent the stories and people of the community. Heritage tourists spend more on travel than other tourists, and this in turn generates jobs in hotels, bed and breakfasts, motels, retail stores, restaurants, and other service businesses. For general information regarding the economic impacts of heritage tourism and historic preservation, visit www.preserveamerica.gov/docs/economic-impacts-of-historic-preservation-study.pdf. More detailed information and statistics on Colorado's heritage tourism industry can be found in "Preservation for a Changing Colorado" published by Colorado Preservation Inc. and found at <https://www.preservationbenefitscolorado.com>.

Sustainable communities

Preservation also helps stabilize neighborhoods and attract investment. Historic neighborhoods convey a sense of community that contributes to the social fabric. Historic districts are often more walkable, which supports healthy living initiatives.

Sustainable growth

Preserving older neighborhoods helps reduce sprawl, reduces landfill impacts, and minimizes automobile trips. It makes use of land already served by utilities and infrastructure. Many older neighborhoods also can support moderate increases in density while retaining their integrity as historic resources. This contributes to the economic viability of the community at large.





NOTE:

Many of the goals, principles and actions for Colorado Main Street communities are similar to those for CLG communities. When these programs are in place, opportunities exist where efforts can be coordinated between the two programs in areas including:

- Training sessions
- Community visits by Main Street and CLG staff
- Annual board retreats
- Collaboration with the local government staff
- Educational programs and events
- Outreach efforts

B. Resources That Can Help

Local level resources

Local government web sites

Many local governments maintain a preservation page on their web sites. These often contain useful links to assistance programs and preservation partner organizations.

Local preservation organizations

Local preservation organizations many times focus on specific local buildings and restoration projects, as well as education, outreach and other cultural events specific to a community. Non-profits often partner together to support a cause and are always good resources for learning more about local preservation issues.

Local historical societies

Historical societies usually focus on promoting awareness of local heritage, maintaining archives and material collections, and operating museums. They often hold records related to historic properties that can be useful in developing rehabilitation plans, historical surveys and tours.

Local Main Street programs

The Colorado Main Street program is designed to assist with the revitalization of traditional downtowns and historic commercial districts, promote economic development and historic preservation. The program uses an approach that advocates a return to community self-reliance, local empowerment, and the rebuilding of central business districts based on their assets, unique architecture, personal service, local ownership and entrepreneurship, and a sense of community.

The Colorado Main Street program provides local technical assistance called the Main Street Approach which is based upon using four key ideas for projects and strategies (Organization, Promotion, Economic Vitality, and Design.) This philosophy and approach are applied to competitively selected communities that are working in historically relevant business district settings and that meet certain threshold criteria.

State level resources

History Colorado

A State of Colorado agency, History Colorado's statewide activities support historic preservation, education, tourism and research related to Colorado's rich western history, offering the public unique opportunities to interact with Colorado history through its network of museums which offer engaging exhibitions and special programs for adults and children.

Through the State Historical Fund historic preservation grants program, History Colorado has awarded millions in competitive grants to all 64 counties across Colorado, which has resulted in a more than \$1.5 billion impact on Colorado's economy.

As the State Historic Preservation Office, History Colorado's Office of Archaeology and Historic Preservation handles the processing and documenting of statewide archaeological and historic preservation related projects. www.historycolorado.org

Colorado Main Street program

The mission of the Colorado Main Street program is to coordinate resources and technical assistance for communities seeking to revitalize their historic downtown commercial districts based on their unique needs. The Department of Local Affairs (DOLA) manages the Colorado Main Street program, which is partially funded by a grant from the History Colorado State Historical Fund. www.colorado.gov/pacific/dola/main-street-communities

Colorado Tourism Office

The Colorado Tourism Office (CTO) was created in 2000 to promote Colorado as a tourism destination. A board of directors oversees the CTO and is comprised of 15 individuals from hotel, restaurant, attraction and other tourism-related businesses as well as Colorado legislators. <http://www.colorado.com> is the official tourism website for the State of Colorado.



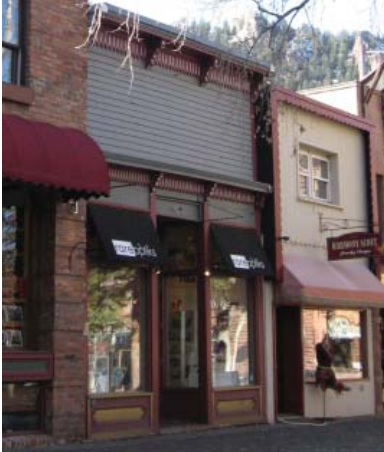

One of the major initiatives of the Colorado Tourism Office is to raise awareness of and appreciation for Colorado's heritage and agri-tourism assets, as described through "A Strategic Plan for Colorado Heritage Tourism Enhancement - 2006." Since the inception of the Heritage Tourism Program, total funding has exceeded \$1.8 million from a variety of partners in addition to the Colorado Tourism Office. <http://industry.colorado.com>

Colorado Preservation, Inc.

Colorado Preservation, Inc. (CPI) is a nonprofit organization that was created in 1984 to promote historic preservation throughout the state by providing advocacy, education, outreach, and preservation services to communities and individuals. The organization is best known for programs such as the Most Endangered Places Program and the Saving Places Conference. www.coloradopreservation.org

Colorado Historical Foundation

The Colorado Historical Foundation is a private nonprofit organization that was established in 1965 to support history and preservation projects. The Foundation carries out numerous preservation-related projects including the historic preservation Revolving Loan Fund for Colorado and an active statewide preservation easements program. www.cohf.org

Downtown Colorado, Inc.

DCI is a nonprofit membership organization committed to building better communities by providing assistance to Colorado downtowns, commercial districts and town centers. Downtown Colorado, Inc. supports local governments in their efforts to support small businesses and grow a sustainable local economy. www.downtowncoloradoinc.org

Colorado Archaeological Society

The Colorado Archaeological Society (CAS) focuses on people having interests in the history and prehistory of humans in Colorado. Their activities include training programs, a newsletter and special publications. www.coloradoarchaeology.org

Colorado Municipal League

The Colorado Municipal League is a nonprofit, nonpartisan organization providing services and resources to assist municipal officials in managing their governments and serving the cities and towns of Colorado.

www.cml.org



Colorado Counties, Inc.

CCI is a non-profit, membership association whose purpose is to offer assistance to county commissioners and to encourage counties to work together on common issues.

www.ccionline.org



National level resources

The National Park Service

The National Park Service is one of the United States' leading agencies for history and culture. In addition to preserving important historic sites within national park boundaries, the National Park Service works beyond those boundaries to ensure that everyone's history is saved. The Cultural Resources Stewardship, Partnerships, and Science Directorate provides leadership for the protection and interpretation of the nation's heritage, guides a national historic preservation program that embraces national parks and heritage resources, engages all American peoples with the places and stories that make up their national identity, and serves as a model for the stewardship of cultural resources throughout the world.

www.nps.gov/subjects/historicpreservation/index.htm

Advisory Council on Historic Preservation

The Advisory Council on Historic Preservation (ACHP) is an independent federal agency that promotes the preservation, enhancement, and productive use of our nation's historic resources, and advises the President and Congress on national historic preservation policy.

The goal of the National Historic Preservation Act (NHPA), which established the ACHP in 1966, is to have federal agencies act as responsible stewards of our nation's resources when their actions affect historic properties. The ACHP is the only entity with the legal responsibility to encourage federal agencies to factor historic preservation into federal project requirements.



As directed by NHPA, the ACHP serves as the primary federal policy advisor to the President and Congress; recommends administrative and legislative improvements for protecting our nation's heritage; advocates full consideration of historic values in federal decision making; and reviews federal programs and policies to promote effectiveness, coordination, and consistency with national preservation policies. The ACHP's major program areas include Preservation Initiatives; Communications, Education and Outreach; Federal Agency Programs; Native American Affairs; and the Preserve America Program. www.achp.gov

The National Trust for Historic Preservation

The National Trust for Historic Preservation, a privately funded nonprofit organization, works to save America's historic places. Based in Washington, D.C. and with a network of regional offices, the Trust works in the field of historic preservation in the United States. The member-supported organization was founded in 1949 by congressional charter to support the preservation of America's diverse historic buildings, neighborhoods, and heritage through its programs, resources, and advocacy. In addition to leading campaigns and advocacy, the National Trust provides a growing educational resource through the Preservation Leadership Forum that offers articles, journals, case studies, and conferences and training. The National Trust issues the quarterly *Preservation* magazine and produces the "PreservationNation" blog, which features stories about people and places in the wider preservation movement. The National Trust's current work focuses on building sustainable communities through the adaptive reuse of historic spaces; preserving and empowering cultural diversity through protecting sites of cultural significance; advocating for greater stewardship of historic places on public land; and leading innovation in the management of historic properties. www.savingplaces.org

National Main Street Center

The National Main Street Center (NMSC) was established in 1980 as a program of the National Trust for Historic Preservation. The organization works with a nationwide network of coordinating programs and local communi-

ties to encourage preservation-based community revitalization. The NMSC also provides information, offers technical assistance, holds conferences and workshops, and conducts research and advocacy on critical revitalization issues.

The non-profit operates on the Main Street Approach which provides a framework for communities to organize themselves for success, to improve the design of their neighborhoods, to promote their district, and to enhance the economic base of a community. www.mainstreet.org

National Alliance of Preservation Commissions

The National Alliance of Preservation Commissions was founded in 1983 in response to amendments to the National Historic Preservation Act of 1966. These amendments provided financial assistance to local governments that met requirements of the Certified Local Government program, including the establishment of a local preservation ordinance and commission. NAPC provides a forum for commissions to discuss mutual problems and to serve as a national voice representing the particular needs of commissions.

NAPC provides technical support and manages an information network to help local commissions accomplish their preservation objectives. Programs include a biennial FORUM conference and Commission Assistance and Mentoring Program (CAMP®). NAPC also serves as an advocate at federal, state and local levels of government to promote policies and programs that support preservation commission efforts. www.napcommissions.org

Preservation Action

Preservation Action is a 501(c)4 nonprofit organization created in 1974 to serve as the national grassroots lobby for historic preservation. Preservation Action seeks to make historic preservation a national priority by advocating to all branches of the federal government for sound preservation policy and programs through a grassroots constituency empowered with information and training and through direct contact with elected representatives. Preservation Action is the only national non-profit dedi-

cated exclusively to lobbying for the best preservation policies at the federal level.

www.preservationaction.org

The Archaeological Conservancy

The Archaeological Conservancy is the only national, nonprofit organization that identifies, acquires, and preserves the most significant archaeological sites in the United States. Since its beginning in 1980, the Conservancy has preserved 500 sites across the nation, ranging in age from the earliest habitation sites in North America to a 19th-century frontier army post.

www.archaeologicalconservancy.org

Archaeological Institute of America

Founded in 1879, the Archaeological Institute of America works to educate people of all ages about the significance of Archaeological discovery and advocates for the preservation of the world's archaeological heritage. The AIA promotes archaeological inquiry and public understanding of the material record of the human past.

www.archaeological.org

CHAPTER 10: LEGAL FOUNDATIONS

This chapter describes the legal authority that communities have to regulate properties for the purposes of historic preservation. It also describes how federal preservation law works, with respect to local commissions. It then provides an overview of some basic procedural requirements that local commissioners must know in order to operate appropriately.

In This Chapter:

- A. Legal Basis
- B. How Do We Find What is Historically Significant?
- C. How Do We Officially Recognize Properties of Historic Significance?
- D. How Does Local Designation Work?
- E. What Legal Issues May Be Raised?
- F. Special Conditions That Ordinances May Address

“Fundamentally, communities do have the right to protect historic properties. However, they must do so within the parameters of laws that affect regulation of property and they must employ accepted operating procedures.”

Tom Mayes, Legal Counsel, National Trust for Historic Preservation

LEGAL REFERENCES

The National Trust for Historic Preservation maintains numerous articles and web-pages related to preservation, which are a valuable reference for local commissioners:

Glossary of Preservation Law Terms:

<http://forum.savingplaces.org/learn/glossary>

Preservation Law 101:

<http://forum.savingplaces.org/learn/fundamentals/preservation-law>

Federal Historic Preservation Laws at a Glance:

http://files.ali-cle.org/files/coursebooks/pdf/CM056_chapter_03.pdf

ADDITIONAL REFERENCE:

A Layperson's Guide to Preservation Law: Federal, State, and Local Laws Governing Historic Resources (Preservation Books).

UNIFIED CODES:

Note that in communities that have adopted a unified development code the preservation ordinance will be a sub-section. Some standard elements of a preservation ordinance may in fact be located in different parts of a unified code. Meeting procedures, enforcement and appeals, for example, may be the same as for other boards and commissions and therefore will be found in a different part of the regulations.

A. Legal Basis

The ability to regulate for purposes of historic preservation is established in state enabling legislation and then implemented at the local level as governments choose to do so. This often occurs as a specific preservation ordinance, but it may also be a part of a more comprehensive set of land development regulations. While some communities may not go as far as creating specific regulations to promote preservation, other existing regulations may have a bearing on historic preservation and may need to be revised if they are a barrier to preservation. Some of the key examples are summarized in this section.

Types of Preservation Ordinances

State Enabling Laws

Local Government Land Use Control Enabling Act (29-20-101)

Local governments provide the authority to regulate the use of property by a number of factors, including preservation of areas of historical and archaeological importance.

1041 Powers (24-65.1-101)

Derived from House Bill 74-1041, this act allows local governments to identify, designate and regulate “areas and activities of state interest,” which includes historical and archaeological resource areas.

Colorado County Ordinance Authority (30-11-107)

Enables counties to designate landmarks and establish historic preservation commissions.

Local Preservation Ordinances

The local preservation ordinance is one of the most important tools that preservation commissions use. It establishes the basic powers and responsibilities of the commission, establishes the criteria for determining significance and for determining appropriateness, as well as a variety of operational matters. (More detail about the composition of an ordinance is provided later in this chapter.)

Many preservation ordinances are written as “stand-alone” documents. In these cases, they include procedures for operations as well as the core elements for preservation mentioned earlier. More recently, some local jurisdictions have incorporated preservation regulations in an integrated, or unified, development code. In these cases, some provisions for commission operations and procedures are distributed into other parts of the code.



Zoning Ordinance

The basic regulations that shape development in a community are part of the zoning code. The zoning code defines permitted uses and densities as well as dimensional limits such as setbacks and building heights.



The zoning code includes base zone districts and overlay districts. Base zone districts provide the regulations that apply to all properties throughout the city while overlays provide additional context-specific regulations in certain defined areas. The code includes base zone districts for residential, commercial, industrial and other uses at varying densities and scales.

In some cases, the requirements of existing zoning districts may conflict with goals and objectives for historic preservation because they allow for development that is out of character with the historic pattern. For example, if maintaining low scale is a goal, zoning regulations that allow significant height increases could be incompatible. In other cases, zoning regulations may be incompatible with preservation goals because they are too restrictive. For example, if a goal is to preserve the character of a neighborhood where houses were typically built very close together, zoning regulations that require a significant setback between properties could be incompatible.

Building Code

Requirements for fire safety, emergency exiting, seismic mitigation and other construction-related issues are part of the building code. Many communities use the International Existing Building Code, and amend it to fit their specific needs, for projects involving historic structures. This provides owners with flexible design solutions that promote preservation objectives and meet code requirements.



Typical Provisions of a Local Preservation Ordinance

Local preservation ordinances vary widely, but the National Trust for Historic Preservation recommends that they comply with these four cardinal land-use principles:

- An ordinance must promote a valid public purpose. That is, it must in some way advance the public health, safety, morals or general welfare.
- An ordinance must not be so restrictive as to deprive a property owner of all reasonable economic use of his property.
- An ordinance must honor a citizen's constitutional right to "due process." In other words, fair hearings must be provided and rational procedures must be followed in an ordinance's administration.
- An ordinance must comply with relevant state laws.

Basic Elements of a Preservation Ordinance

1. Statement of Purpose

Clearly state its public purpose.

2. Preservation Commission Established

Describe the qualifications of commission members as well as their terms of office.

3. Commission Powers and Duties

Typical duties: to conduct historic surveys, maintain inventories, undertake design review and keep adequate records of actions.

4. Criteria for Designating Historic Properties

Establish basic, objective criteria for evaluating significance.

5. Procedures for Designating Historic Landmarks and Districts

See “due process” requirements described in Chapter 5.

6. Reviewable Actions and Procedures

Describe what types of changes --e.g., demolitions, building/landscape alterations or new construction in historic districts-- are subject to review.

7. Standards for Review

These may be broad standards, which can then be elaborated in more detail in accompanying design guidelines.

8. Economic Hardship

Include a process and standards for evaluating economic hardship claims.

9. Interim Protection Provisions

Provide for interim protection for buildings nominated but not yet designated.

10. Minimum Maintenance (Demolition by Neglect)

Include “affirmative maintenance” provisions to prevent negligence in maintenance.

11. Enforcement and Penalties

Define penalties for violating the ordinance.

12. Appeals

Establish a method for appeals by aggrieved parties. State and local laws determine how appeals are made.



Rules of procedure (By-Laws)

In addition to the ordinance, commissions should adopt rules of procedure. These apply to many different kinds of commissions and boards and describe in more detail the steps for conducting business. They may be adopted separately, but sometimes are embedded in the preservation ordinance.



Some typical provisions in rules of procedure are:

Meetings

- Schedule (e.g., once a month)
- Attendance requirements (maximum of excused absences)



Filing an application

Schedule for filing an application in advance of a hearing. Submittal requirements, such as:

- Application form
- Building permit application
- Drawings and specifications of proposed work
- Photographs of property (building and site) and context

Public notification of a hearing

- A sign posted at the site
- A published announcement

Process for public comment

- At a public hearing
- Prior to a public hearing

Public hearing process

- Receiving applicant's presentation
- Receiving staff comments
- Receiving comments from the public
- Questions by the commission

Decision-making

- Requirement of a quorum
- Rules for discussion among the commission
- Making a motion
- Voting
- Disposition of the agenda item (by vote)
 - Approval as submitted
 - Approval with modifications indicated at the meeting
 - Continuation to another meeting
 - Denial



Consent agenda

In order to expedite decisions and manage meeting time effectively, commissions may assign projects to a “consent docket,” in which all items are approved in a single motion in cases where there are no adverse comments by fellow commissioners, staff, or the public. Procedures permit removing an item from the consent docket if there are concerns to address.



Pre-application conference

A meeting before the formal hearing is a valuable way to assure that a proposal is headed in the right direction. Scheduled with staff, this provides an opportunity to advise applicants before they expend substantial time and money on a design proposal.

Recording decisions

The rules of procedure will also describe the requirements for recording decisions. Most hearings are audio or video recorded to retain a basic record of the proceedings. Written minutes, including decisions, are usually prepared. Some commissions only require detailed written decisions when the action is not by unanimous consent.



Rules of Procedures, continued...

Administrative approval

The rules of procedure may also define a process for administrative approval and define project types that fall under this category. Generally, projects eligible for administrative review are limited to minor alterations and repairs that replace features in-kind.

Ex parte communication

A key consideration is how to handle communications about a pending application that occur outside the public hearing (*ex parte*). This may be a casual encounter with the applicant on the street, for example, in which they make a comment about their project. While such communication should be avoided, it is not always possible to do so. If an *ex parte* communication does occur, the rules of procedure usually require that fact to be announced at the hearing, and the commissioner involved may recuse him or herself from participating in a discussion about the property if there is concern about a conflict of interest.

Location of rules of procedure

In many cases, the rules of procedure are adopted as a stand-alone document. This facilitates amending it without requiring changes to the preservation ordinance.

Even so, some of these procedures may be included in the preservation ordinance. Furthermore, in communities that have adopted a unified development code, in which several “stand-alone” ordinances are consolidated, some procedural requirements that apply to all boards and commissions may be located in separated sections of the development code. Commissions adopt rules of procedure by a majority vote.

B. How Do We Find What Is Historically Significant?

Identifying which properties have historic significance is an initial, and important, step in a local preservation program.

Professionals, historians, preservationists, and architects work with staff, commission members, and advocates to evaluate properties, using adopted standards that are recognized nationally. They employ a variety of research tools to assist them in making those determinations. These nationally-recognized standards are created and maintained by the Secretary of the Interior through the National Park Service.

Tools used to identify historic properties:

Surveys

In a historic resource survey, information is collected about the history and condition of properties in a targeted area.

The survey process includes a field inspection, collecting historic information about the physical and cultural history of the property and documenting it in photographs, drawings and maps. Additionally, the survey will include a description of the key characteristics of individual properties as well as the defining characteristics of groups of buildings.



OBJECTIVE CRITERIA:

It is important that surveys be conducted in an objective manner, using criteria that have been adopted by the commission. These should be consistent with those employed by the Secretary of the Interior, but may include other criteria as well.



NOTE:

History Colorado provides valuable survey information and forms. To see a list of forms and manuals, visit

<https://www.historycolorado.org/survey-inventory-forms>

NOTE:

An INVENTORY is distinct from official designation as a historic resource in a historic REGISTER, in that being on the inventory usually does not involve regulation of property, whereas official designation as a landmark usually does.

NOTE:

History Colorado maintains a database, through its Office of Archaeology and Historic Preservation of many properties that have been surveyed. Titled the “Colorado Cultural Resource On-line Database,” it is available to qualified users. <https://www.history-colorado.org/compass>

COLORADO CULTURAL RESOURCE SURVEY MANUAL

Guidelines for Identification: History and Archaeology

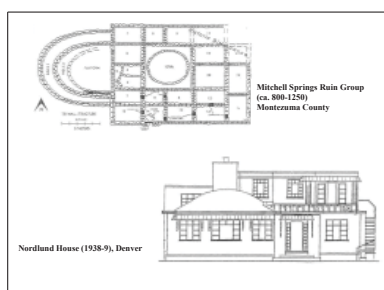

Revised 2007



OFFICE of ARCHAEOLOGY and HISTORIC PRESERVATION

There are two types of architectural surveys that can be completed, an intensive survey and a reconnaissance survey. Reconnaissance level surveys (also known as windshield surveys) are the most common and are typically used for Section 106 Review consultation. These are visual or predictive surveys that identify the distribution, location, and nature of cultural resources within a given area. Intensive surveys, on the other hand, combine the reconnaissance survey with an evaluation by a trained professional, and involve in-depth archival research and field work to record all properties in the survey area.

More information about surveys is discussed in Chapter 4, and History Colorado provides a survey forms that most communities use.

Inventories

An inventory is a catalog of survey information, organized by individual property addresses, that is maintained by a community. It includes those properties identified as having significance, as well as others that have yet to be evaluated, and those that have been evaluated and found to lack historical significance. Inventories are informational and not regulatory.

Establishing historic significance

Commissions apply a set of formally adopted criteria when evaluating survey information about properties. These are generally consistent with those established by the Secretary of the Interior for evaluating eligibility to the National Register of Historic Places.

Typically, in order to be eligible for listing as a property of historic significance, it must first meet a set of threshold criteria related to age and integrity; based on a property’s ability to convey its significance, or its integrity, a property can then be considered for National Register listing. The evaluation of integrity is sometimes subjective, but it must be grounded in the evaluation of the property’s physical features and how they relate to the significance of the property.

History Colorado provides a guide to surveying that includes criteria that most communities use.

Threshold criteria for eligibility are:

Age

Generally, a property must be 50 years old or older at the time of nomination. However, each Commission is able to set its own age requirement, meaning the time requirement for nominations can vary between all communities. For instance, Greeley has no age requirement for nomination, meaning that significant modern buildings can be nominated, while Denver has a 30 year requirement for nomination.

Significance criteria

A property must then have significance in one or more categories. Typical categories are:

- Association with historic events or trends
- Association with individuals who made a demonstrable and lasting contribution
- Architectural or engineering merit
- Potential to yield information that will contribute to a better understanding of our past (archaeological)
- Geographic importance of a property, referring to its location and its recognition as a visual landmark

Historic contexts and themes

Historic contexts discuss the patterns and trends that produced individual properties in the community, providing base information but not functioning as a regulatory tool. The core premise is that properties represent inter-



INTEGRITY:

In addition to demonstrating significance, a property must retain physical integrity to reflect that significance; it must not have been altered substantially since the period when the event occurred, or the person lived there. That is, it must retain its "integrity."

weaving factors in history and did not occur in isolation. These are used in understanding potential significance. Themes group information related to historic resources based on a subject, specific time period or geographic area. The relative importance of individual historic resources is better understood by determining how they fit into a theme. Individual historic resources may relate to more than one theme.

Integrity

Aspects of integrity include:

- Location
- Design
- Setting
- Materials
- Workmanship
- Feeling
- Association

It must retain sufficient integrity in most of these aspects to convey its historic, cultural, or architectural significance.

Contributing Property



This building retains its integrity.

Contributing Property with Some Alterations



Although somewhat altered, this building retains sufficient integrity to be considered for historic significance.

Non-Contributing Property with Major Alterations



This building does not retain its integrity. It would be considered to be a "non-contributor" in a district survey.

The Identification and Designation Sequence

Commissions use an orderly process for conducting surveys and entering the data into an inventory. They then evaluate the significance of properties, and decide how to respond to those findings. This may lead to nomination to one or more historic registers. This chart displays the identification process, in combination with the subsequent, optional, designation process. However, while the chart outlines an orderly process, it is important to keep in mind that not all designations occur in this way or this linearly. Sometimes, a property owner may wish to nominate their individual property and may complete the research and nomination process individually, without the benefit of a survey. Commissions generally nominate properties when a complete district is being discussed, but even so, these nominations are many times completed through leaders in that neighborhood. Regardless of who nominates a property, the diagram below illustrates the steps in the nomination process, whether it be for an individual property or a district as a whole.

IDENTIFICATION AND DESIGNATION:

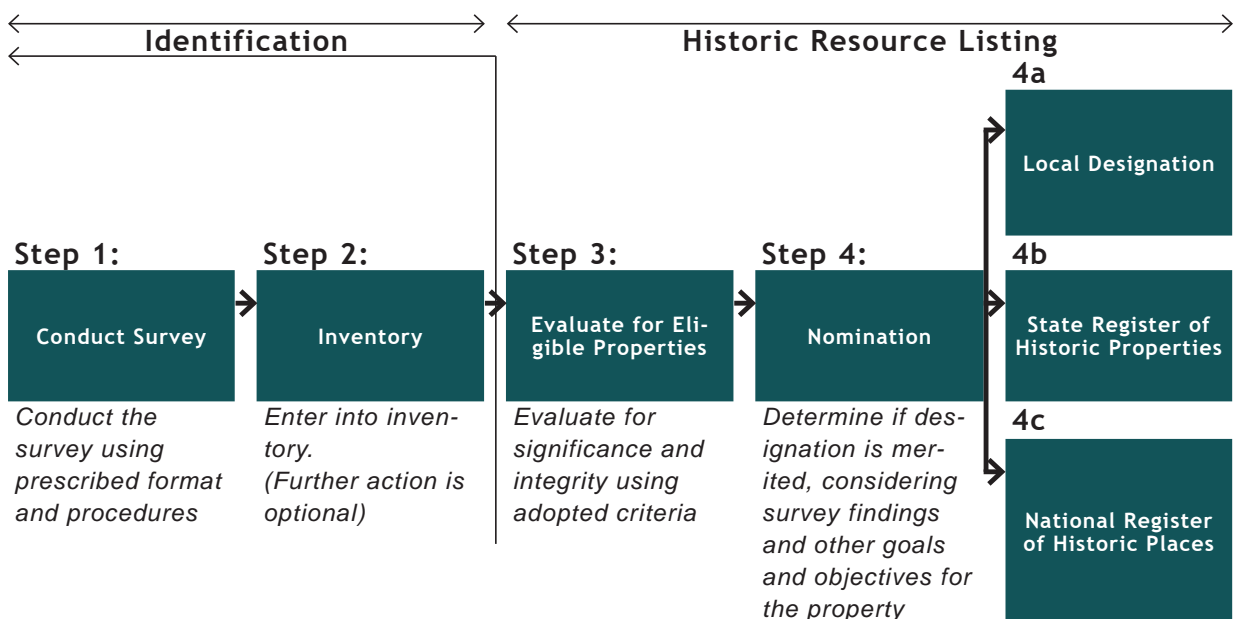

SURVEY VS. DESIGNATION:

It is important to distinguish surveys from the separate process of historic designation and protection. Surveys gather information about the history and characteristics of properties, while designation lists a property as having legal historic status. A survey may determine that a property is eligible for designation, but it does not initiate designation proceedings. Often, eligible properties remain undesignated.

Although historic surveys do not officially designate properties as historic, the information gathered is useful to build awareness of historic buildings and sites and inform property owners of potential benefits and incentives that may be available.

C. How Do We Officially Recognize Properties of Historic Significance?

Once determined to have significance, properties may be designated as “landmarks” or as part of a “historic district” in a process that follows legal requirements as defined by the Federal, State or local government making the decision. “Historic Register” is a term that refers to a listing of properties that are officially designated as historic and appear in either the National Register of Historic Places, the State Register of Historic Properties and/or a local register. Properties on a historic register may be eligible for special benefits and subject to specific requirements.

Types of designation

Historic properties may be designated at one or more of these levels:

- Federal (The National Register of Historic Places)
- State (The Colorado State Register of Historic Properties)
- Local government level

While commissioners only designate properties at the local level, properties may be discussed for designation at more than one level. Commissioners should always be clear what level they are referring to when discussing a property so as to not confuse the public. State Register nominations require owner consent, while the National Register process allows for owners to object, and if a majority do, the nomination is dropped.

National Register of Historic Places

The National Register of Historic Places (National Register) recognizes districts, buildings, structures, objects and sites for their significance in American history, archaeology, architecture, engineering, or culture, and identifies them as worthy of preservation.

The National Register was enacted by Congress in the National Historic Preservation Act of 1966. This established a process for nominating properties to the register and provided for a system of criteria to use in determining significance.

The National Register is a program of the U. S. Department of the Interior, National Park Service, and is administered at the State level by Colorado’s State Historic Preservation Office (History Colorado). Note that while it is named the “National Register,” properties may also be significant at a state or even a local level. They must, however, meet the National Register criteria.

Effect on property owners

Listing in the National Register honors the property by recognizing its importance to the community, state or to the nation, and confers a measure of protection from harm by federal activities through section 106. It does not, however, place any restrictions on the actions of private property owners.

Listing in the National Register is also the effective threshold for eligibility for a variety of economic incentive programs designed to assist in the preservation of significant properties, including federal and state tax credits for certain types of rehabilitation work. Other financial incentives for preservation may include grants and loans. Donations of preservation easements on Register-listed properties also may qualify for charitable tax deductions.



NATIONAL REGISTER LISTING IN COLORADO:

As of 2016, 1,480 listings, from all of Colorado’s 64 counties, can be found on the National Register of Historic Places (NRHP), the nation’s official list of properties deemed worthy of preservation. In Colorado, the National Register program is administered by the Office of Archaeology and Historic Preservation within History Colorado.

To search for properties that may be listed: <https://www.historycolorado.org/properties-listed-national-state-registers>



CERTIFIED LOCAL GOVERNMENT STATUS

The State Historic Preservation Office (History Colorado) and the National Park Service certify local governments to participate in state and federal preservation programs. As a Certified Local Government (CLG), a community is eligible for special grants and tax incentive programs. Maintenance of CLG status, however, includes specific responsibilities, such as maintaining a system for survey and inventory of historic properties.



Note that listing in the National Register does not place any restrictions on the actions of private property, as distinguished from LOCAL level designation, which is described below. A property listed only in the National Register may be altered or demolished, following general building, zoning and demolition codes of local communities.

State designation

The Colorado State Register of Historic Properties program is administered by the Office of Archaeology and Historic Preservation within History Colorado. Properties listed in the National Register of Historic Places are automatically placed in the Colorado State Register of Historic Properties. They may also be nominated separately to the Colorado State Register of Historic Properties without inclusion in the National Register.

Listing in the State Register is similar to listing in the National Register in that it does not place any restrictions on the actions of private property owners. This listing honors the property by recognizing its importance to the community and the state, and confers a measure of protection from State actions. Listing in the State Register requires that any project undertaken, funded or permitted by an Agency of the Colorado State Executive Branch be reviewed by History Colorado.

Local level designation

A property may be designated as a historic resource under local zoning laws. This, of course, is the type of designation in which local preservation commissions are involved in most cases.

D. How Does Local Designation Work?

A community may adopt regulations related to preservation of historic properties, which can include a process for officially designating resources to a register. Adopted by ordinance, this may provide for review of alterations and demolition as well as make certain incentives available to eligible properties. For CLG communities, alterations must be reviewed, even if that review is not binding. Local designation is the designation that preservation commissions use in their review and permitting roles.

The legal basis for local designation

At the local level, any local ordinance must be in agreement with the applicable state enabling legislation as county and municipal governments can only exercise those powers specifically delegated to them by the state.

Designation is a form of zoning overlay.

Because historic designation is a land use activity, it is considered a zoning overlay. In land use, an “overlay” adds other provisions to the underlying, base zoning. In the case of preservation, this typically adds the requirements for review by the preservation commission, and also any special benefits that may be offered. Historic area overlays do not alter the underlying base zoning, and commissions usually do not have the authority to deny or approve applications based on use. However, some governments allow uses and “special exceptions” for designated properties that are different than what would normally be allowed by the underlying zoning. This is one example of a special benefit that might be offered to property owners.

THE COMMISSION'S ROLE:

Note that in many communities, the commission's role is advisory in the designation process. In some communities, the commission makes the formal decision with appeals going to a governing body, while in other communities, the governing body makes the formal decision with recommendation from the commission.



FOLLOWING DUE PROCESS:

Commissioners should take care in their actions to assure that procedural due process is provided.

PENN CENTRAL DECISION:

The Supreme Court ruled in its decision regarding a takings claim by Penn Central in New York City that a taking had not been demonstrated, and that a local preservation commission had the right to regulate a property.

This case is the basis for hardship tests.

For more information, see:

<https://www.casebriefs.com/blog/law/property/property-law-keyed-to-cribber/regulatory-takings/penn-central-transportation-co-v-city-of-new-york/>



E. What Legal Issues May Be Raised?

Even though local governments have the right to designate and regulate properties, historic preservation ordinances and commissions may face legal challenges. Often these are raised as concerns during the designation and design review processes, and sometimes they may even lead to formal consideration in the courts. This section discusses some of the most common legal issues a commission may face and some best practices that commissions should follow to protect themselves from legal vulnerability.

Takings

One of the most frequently challenged issues is whether designating private property as “historic” and thus subjecting it to local government regulation constitutes a “taking” for which the government unit must pay. The term “taking” derives from a provision in the Fifth Amendment to the U.S. Constitution that states that private property shall not “be taken for public use, without just compensation.”

In general, the courts have interpreted a “taking” to occur only when no viable use of the property remains from the governmental action. That is, limiting use, or in some cases, prohibiting certain alterations or even demolition, is not considered a taking.

The courts have upheld local governments’ ability to regulate for preservation, finding that the restrictions that may be applied do not constitute a taking. That said, the courts do consider closely if a property owner’s rights for due process have been followed and if the criteria they use are clear and understandable. (See the 1978 Colorado Supreme Court Ruling related to Georgetown in Chapter 1, page 24.)

Procedural due process

While local governments do have the right to regulate properties for preservation, they must do so following procedural due process. That is, each affected property owner must be given proper notification of pending governmental action, and be provided the appropriate hearing of their concerns.

Procedural due process is essentially based on the concept of “fundamental fairness.” Procedural due process refers to the manner in which government actions are carried out, that is, the actual process of decision-making.

Procedural due process requires:

- Advance notice of the proceedings
- Final notice of the decision reached
- Opportunity for individuals directly affected by the proposed governmental action to be heard

Commissioners should take care in their actions to assure that procedural due process is provided, such as notifying applicants of hearing dates and providing time for public comment during a hearing.

Substantive due process

Substantive due process is a related concept. It addresses the rationality or reasonableness of the substance of the decision itself. It requires that the decision be based on the evidence on the record as applied to the standards and criteria in the ordinance. It also protects individuals from bias, conflicts of interest, and other factors bearing on the impartiality of the decision-makers. Commissions should take care to make findings of fact and reference all applicable standards and criteria when taking action on a property. Commissioners must also recuse themselves from discussions about applications, properties, or issues if there is a real or perceived conflict of interest. Failing to do so could create legal vulnerabilities for the individual, the commission, and the local government if the decision is challenged in the future.

RECUSE:

When there is a perception of a conflict of interest, a commissioner may recuse themselves from a hearing. When they do, they announce the fact and leave the room for the duration of the item on the agenda.





F. Special Conditions That Ordinances May Address

Economic Hardship

“Economic Hardship” is a specific condition that can only be determined using adopted criteria and carefully following procedures outlined in the ordinance. Commissioners should not show their personal feelings about this condition.

This is often an emotional issue, but commissioners should not feel that the question should be avoided. Sound legal precedent indicates that the government, including the preservation commission, can engage in regulations that may raise this question.

What is it?

Economic hardship exists only when NO reasonable use of a property is available to the owner, due to the regulations in the preservation ordinance. It is based on language in the Fifth Amendment of the United States Constitution.

The term “reasonable use” is key. If a property is limited in its use due to the regulation, such that the owner cannot maximize the economic benefits, but there is still a reasonable return, then no takings is found to exist.

Also note that the “hardship” is with the PROPERTY itself, not with the owner. That is, one’s personal finances are not a part of the consideration.

The preservation ordinance should provide a specific process and criteria for determining if an economic hardship exists, and commissioners should follow them carefully.

How should a hardship claim factor into project review?

The commission should consider an economic hardship claim separately from an application to demolish a building. The first step is to decide if demolition is permitted, regardless of economic circumstances. Then, if demolition is denied, a separate hearing should consider economic hardships. This separation of actions makes it clear that the demolition itself remains “inappropriate,” but is permitted because of economic hardship.

The permit to demolish

Under some ordinances, an application to demolish requires a Certificate of Appropriateness (COA) or a similar permit.

A demolition permit might be issued if:

- The property is a non-contributor in a historic district.
- The property, although presently listed as contributing, is found to have lost its integrity and thereby merits reclassification as non-contributing (e.g., through damage from a fire or a natural disaster).

The hearing for the demolition permit should be based on the facts related to the significance of the property. If it retains its integrity, then demolition should be denied.

Finding economic hardship

While the claim for hardship may be made as a part of an application to demolish a building, it should be handled as a separate agenda item, and the specific test for hardship should be applied.

That is, the commission in the first hearing would find that demolition is inappropriate, but then in the second hearing find there is an economic hardship (if that is the case), which would then justify issuance of a demolition permit.

Usually, if no economic hardship claim is made, a commission will deny an application to demolish a historic building since its primary objective is preservation of such resources.

Demolition delay

Some ordinances do not give the commission the power to deny demolition, and only provide for a delay in issuing a demolition permit. The intent is to provide some time to find an alternative, such as selling the property to a buyer who will maintain it.

These provisions usually delay only for a defined period of time (e.g., 90 or 120 days). The claim of economic hardship is less likely to occur in this situation.

Economic assistance

A special case of concern is the situation with an owner-occupied home, in which the owner lacks the financial means to maintain their property adequately. They may assert that a requirement to use proper rehabilitation procedures is an “economic hardship.”

Technically, this is not the same as the hardship related to the Fifth Amendment, but the public may confuse the two. Ideally, the local government will have assistance and incentives programs to help owners make appropriate improvements for these situations. Incentives may include state and local tax credits for rehabilitating historic structures. For more information about incentives, refer to Chapter 9.

Evidentiary Checklist for Economic Hardship

What type of evidence should be reviewed when considering economic hardship? The National Trust for Historic Preservation, in its publication *Assessing Economic Hardship Claims Under Historic Preservation Ordinance*, provides this checklist of information that is a useful tool for local commissions and other regulatory agencies considering economic hardship claims:

- 1. Current level of economic return**
- 2. Any listing of property for sale or rent, price asked, and offers received, if any, within the previous two years, including testimony and relevant documents**
- 3. Feasibility of alternative uses for the property that could earn a reasonable economic return**
- 4. Any evidence of self-created hardship through deliberate neglect or inadequate maintenance of the property**
- 5. Knowledge of landmark designation or potential designation at time of acquisition**
- 6. Economic incentives and/or funding available to the applicant through federal, state, city, or private programs**

This paper is available at: <http://bit.ly/2AynTZs>



Demolition by Neglect

Simply put, intentionally allowing a property to deteriorate to the point that it cannot be saved is “demolition by neglect.” The assumption is that the owner is capable of maintaining the building, but chooses not to do so.

What is the issue?

The concern about demolition-by-neglect is that a building can lose so many of its key features that it will no longer retain sufficient integrity. If that happens, then the building will no longer have historic significance, at which point outright demolition may be permitted under other governmental regulations.

This is especially an issue when an owner may have been denied a permit to demolish a building and, in response, simply lets it decay, perhaps even opening it to the elements to accelerate damage.

Demolition-related tools

Tools that prevent or discourage the demolition of historic resources are essential elements of a community’s preservation system.

Sometimes a property is neglected until it must be demolished. These cases of “demolition by neglect” may reflect many causes including:

- An owner cannot afford the necessary maintenance because of personal financial circumstances, or
- An owner is unwilling to invest in the structure, or
- An owner anticipates reuse opportunities for the site that seem to be greater without the historic structure being there, or
- There is no apparent viable economic use for the property, or
- An owner is disinterested or unaware of the condition of the property, or
- At a certain point, the decay becomes so substantial that the City’s or County’s building official must cite the property as a hazard to public safety. Most local preservation ordinances acknowledge that, when this state is reached, the property may be demolished. The objective, however, is to avoid having a property reach this state.

Typically, by the time a building reaches this stage, it has already passed a point at which many of the architectural details and building components that contribute to its significance have deteriorated beyond repair. That is, when it reaches a public safety hazard stage, the building may have already lost its integrity as a historic resource. The challenge, therefore, is to interrupt the cycle before decay reaches this stage.

Tools to Prevent the Loss of Historic Resources

Typically, the primary demolition prevention tool is a requirement for a demolition permit. Other strategies to protect historic resources from demolition include direct intervention, and incentives as well as working to create a climate that encourages good stewardship. Because the appropriate tools will vary with the circumstances of the case, the most effective preservation programs use these tools:

- Property owner notices of need to repair
- Publication of endangered property lists (often managed by preservation partners)
- Emergency protection clauses in the ordinance
- Minimum maintenance requirements
- Forced sale or condemnation
- Emergency preservation funds
- Removal of inverse incentives
- Creating a supportive economic environment

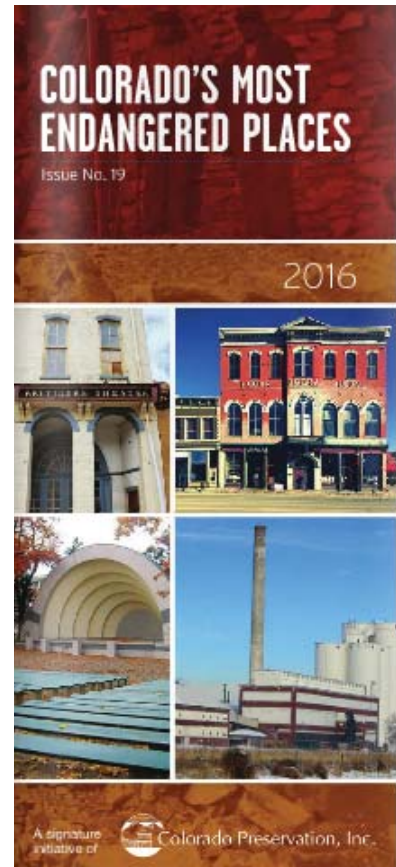

How should it be handled?

Address this issue with care. Some local ordinances have provisions for dealing with cases of demolition-by-neglect, most allowing for:

- Issuing a civil (and sometimes criminal) citation
- Ability of the government to undertake necessary corrective work
- Putting a lien on the property

Citing for demolition-by-neglect requires discretion. Ideally, the commission will adopt specific criteria for identifying demolition-by-neglect.

The ordinance also may limit the use of this provision to specific classes of property, such as:

- Unoccupied structures
- Structures open to the elements
- Major landmarks
- Properties in designated revitalization areas

Enforcement of demolition by neglect

The practical reality is that it is rare for a local government to step in and renovate or stabilize a deteriorated historic building and then bill the owner. Few local budgets have funds earmarked for such activities and it would be unpopular. At most, the local government may board up a building or cover a leaking roof with a tarp - a short-term solution.

Use it with care

For this reason, it is important to employ this provision with care. It is useful, however, to have such a provision in the ordinance. It serves as a potential deterrent and is then available for really critical conditions or highly valued buildings.

Communicate first

Talk to owners first if substantial deterioration is identified, and document all efforts to communicate with them. Citing for demolition-by-neglect should only occur after demonstrating that the government has done everything possible to resolve the situation.

Enforcement

A preservation ordinance, in cases where the commission is not simply advisory, may establish a procedure for enforcing its terms. The ordinance should clearly establish a procedure for identifying, a process or timeline of trying to remedy identified issues and a final solution or enforcement action. Any process or enforcement should also clearly identify who is responsible for key milestones or enforcement actions. An ordinance is usually enforced through stop-work orders and the assessment of fines and other penalties for individual violations. Any enforcement and its extent is not mandatory and depends upon the local jurisdiction.

The Commission may request that enforcement action be taken for a violation, if the situation is brought to their attention. Note that the Commission does not actually cite the property owner in violation, as it is not the Commission's role or responsibility to police violations.

What is the HPC's role in enforcement?

The commission plays an advisory role. City or county staff is responsible for issuing citations and any related penalties, since this is a part of the municipal code. This may be a code enforcement official.

The Commission may request that enforcement action be taken for a violation, if the situation is brought to their attention, but it is not their responsibility to police violations. Again, while every community may establish a different procedure for enforcement, it is crucial that a clearly defined process is made known.

CHAPTER 11: WHERE DO WE GO FROM HERE?

The preceding chapters provide an overview to the key components of a preservation program at the local level and notes some of the benefits of preservation to the community. They even touch on some of the trends that may affect ways in which commissions operate. Now, it's time to place that information into a broader context. This final chapter therefore returns to some of those earlier topics and presents them in a more holistic view.



In This Chapter:

- A. Current Trends
- B. Keep Challenges in Perspective
- C. Reaching Out
- D. Your Work is Valued!
- E. Thank You for Your Service!



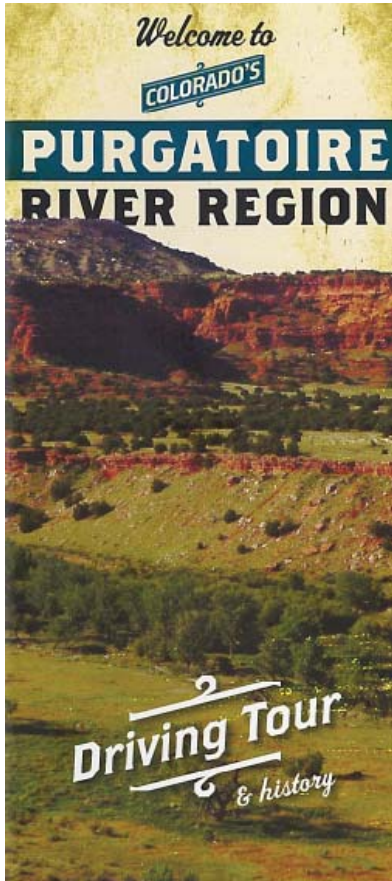

A. Current Trends

Preservation programs continue to address new issues and opportunities in response to changing trends in community development and public policy. These include considerations of sustainability, public health and economic development. Other changes relate more specifically to technical aspects within the field itself, as new technologies are applied to traditional components of preservation programs and as awareness about what constitutes heritage continues to evolve. Preservationists should be alert for these changes and be prepared to respond to these new issues and opportunities. Here are some examples of current trends:

Heritage tourism

The tourism industry is the second-leading industry in the nation, creating local jobs, business opportunities and enhancing property values. Well-developed tourism programs improve the quality of life and instill pride in communities throughout the state. Preservation commissions know that keeping historic resources in good condition is a fundamental cornerstone of a heritage tourism program. By protecting these places, the heritage tourism “product” will be available for others to use and experience.

Place value

The concept of “Place Value” is described through a report published by Community Builders and illustrates a fresh approach to economic development in the West. This report discusses new approaches to economic development that respond to a changing market and fiscal realities, as well as changing priorities of people deciding where to live, work or start a business. Place value also indicates that people are living in and moving to places for their unique identity; with this in mind, preserving historic downtowns plays a key role in making a place distinctive, and will help attract new residents and businesses to an area.

Healthy community initiatives

Planning for community health is growing as a field of interest. For preservationists, this means demonstrating that older neighborhoods and downtowns provide walkable places that encourage exercising and that offer opportunities to access goods and services. It also means thinking about how daily needs and services can be accommodated within convenient walking distance of historic neighborhoods and about how historic buildings can be adapted to house services related to healthy communities. This includes providing access to healthy foods as well as places for social interaction as a community.

New ideas about diversity

A growing number of people are interested in broadening the diversity of those socio-economic groups that are represented in the resources that we seek to protect. This includes racial minorities and members of distinct cultural groups. It also extends to engaging representatives of these groups in actively preserving resources and in joining local commissions. As historic neighborhoods experience changing demographics, the way in which they are used and valued can change. This brings a new level of “richness” to the meaning of these places.

Coordinating with other planning initiatives

Commissions will continue to see their programs more closely coordinated with other planning movements. This includes comprehensive plans as well as affordable housing programs, and sustainability initiatives. Commissions will also see a range of tools being refined to help address community character; sometimes these tools may be applied as alternatives to historic district designations. These include the use of conservation districts, form-based codes and other more context-sensitive zoning.

New incentives for preservation

Commissions will see new types of incentives that are offered to reward good stewardship of historic resources. These may include offering sales tax rebates on materials purchased locally that are used in appropriate reha-

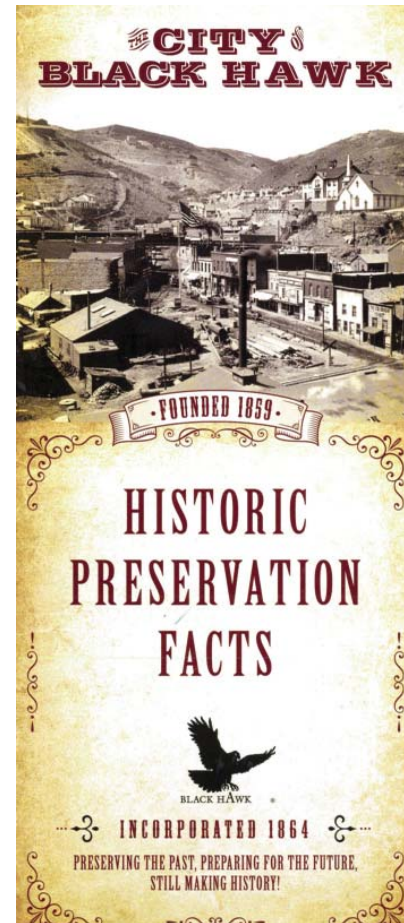

bilitation projects, greater flexibility in zoning codes and technical assistance in planning improvements to historic properties.

Recognition of new types of resources

Increasing interest in identifying properties from “the Recent Past,” such as those from the mid-twentieth century and later, as having historic significance, will continue. These resources will also stimulate new approaches to their “treatment,” in terms of how best practices in preservation may apply to them. Some of these buildings were constructed with new, experimental materials of the time and may raise new technical issues.

New technologies

Emerging technologies will continue to provide new ways of identifying historic resources and in managing them. This includes use of digital devices in the field to survey historic resources, the use of Geographic Information Systems in combining survey information with other planning information and the use of smart phones and related devices in heritage interpretation and tourism.

These are among the exciting trends that bring new opportunities and issues to those engaged in preservation. This leads to the need for on-going education and promotion related to preservation.

B. Keep Challenges in Perspective

There also will be losses. Each commission encounters some situations in which resources are lost, for a variety of reasons. While these will be disappointing, it’s important to keep a perspective. What is most important is to handle these disappointments in a professional manner and to recognize that for each of these losses

there are many, many successes. Often, a commission's achievements go less appreciated because they attract less public attention.

There also will be a time when a controversy arises which the public may not fully understand. This also is a time to remain calm and proceed following proper procedures and to recognize that explaining your actions is sometimes just as important as the actions themselves.

In all of these situations, keep the long-term life of the preservation program in mind; rest assured that over all, the cumulative benefits of individual preservation actions in your community will be appreciated in the future!

C. Reaching Out

Looking forward, the role of commissions as “ambassadors” for cultural heritage will continue to be a key role. These are some ways in which that is happening:

Education and promotion of preservation

An on-going need exists to further public recognition of historic resources and build an awareness of best practices in their stewardship. It's also important to continue to report on the successes of HPCs such that the public better understands your positive contributions to the community.

Building partnerships

Commissions must continue to build partnerships with other community groups, property owners and interested citizens to collaborate on projects that involve historic properties and districts. It's an important team-building role with others in the community.

There is help out there!

Commissions are not alone in promoting historic preservation. First, there are other peer commissions across the state who can provide a network of support. Other special resources are statewide preservation organizations, including History Colorado and the Colorado Main Street Program. At the national level, the National Alliance of Preservation Commissions is a very useful resource.

D. Your Work is Valued!

It's important to know how valuable commissions and their staff are to our communities. As commissioners, you're a part of the future of preservation and of Colorado. While the focus of your responsibilities may be on preserving historic resources, they also contribute in many aspects to community development and livability. In that respect commissioners play an extremely valuable role in promoting awareness and understanding of our historic resources and of the methods used to protect those resources.

It is also important to keep a long-term perspective. Some preservation actions that you conduct today may not be immediately recognized as being important, but in future years will be. This may be working to save a resource that is not immediately recognized as being of high value by the broader community, or it may be establishing a new program to build awareness and appreciation of historic preservation. These achievements will be recognized in the future as being invaluable in promoting historic preservation, even if not so immediately.

E. Thank You for Your Service!

Finally, thank you for your service. Commissioners, staff, elected officials, and community organizations and partners give their time to their communities in the interest of promoting the public good. You are appreciated!

GLOSSARY

Approve

To pass a motion by the process of voting, usually by majority or a predetermined percentage “for” vs. “against” votes.

Character-defining features

(Related to descriptions of property types and styles)

Character refers to all those visual aspects and physical features that comprise the appearance of a historic building. Character-defining elements include the overall shape of the building, its materials, craftsmanship, and decorative details, as well as the various aspects of its site and environment.

Certificate of Appropriateness

When a historic preservation commission or design review board reviews and approves proposed changes to a historic building, they issue a Certificate of Appropriateness, a document stating that the proposed work is appropriate for the historic district or building and meets local code criteria.

Compatibility

(Related to application of design guidelines/criteria, for alterations and new construction)

Designing new buildings or alterations that fit in the context of the historic neighborhood. Some elements of compatible design are: keeping a sense of human scale, using building features and materials of a familiar dimension, such as traditional brick, to maintain the visual continuity in the neighborhood.

Conflict of interest

(Related to hearing procedures and Due Process)

Occurs when an individual or organization is involved in multiple interests, one of which could possibly corrupt the motivation for an act in the other.

Conjectural

(Related to replacement or reconstruction of missing details)

The inappropriate replacement or reconstruction of building parts and details based upon speculation and not physical evidence, historic photographs or written documentation.

Continue

The postponement of a case to a later date, usually the next commission meeting.

Contributing property

(Related to Historic Survey & Designation)

A contributing property is any building, structure, object or site within the boundaries of a historic district which reflects the significance of the district as a whole, either because of historic associations, historic architectural qualities, or archaeological features. Another key aspect of the contributing property is historic integrity.

Criteria for designation

(Same as Criteria for Significance)

Established principles or standards for evaluating the eligibility of properties for inclusion in a formal listing of historic resources.

Criteria for significance

(Same as criteria for designation)

Demolition

The tearing down of a portion of, or an entire building or other structure.

Demolition by neglect

Any willful neglect in maintenance and repair of a structure, not including appurtenances and environmental settings, that does not result from financial inability to maintain and repair the structure and that threatens to result in any substantial deterioration of the exterior features of the structure.

Demonstrated special interest

Historic preservation commissions typically include residents who have shown special interest or experience, or education in history, architecture, archaeology, or other preservation-related fields.

Deny

(Option for a motion action; related to approve, approve with conditions and continue)

A decision which prevents the application for an action from being executed; when a local preservation commission denies an application for a Certificate of Appropriateness, the work proposed is not authorized.

Design guidelines

(Related to Secretary of the Interior's Standards and Guidelines, and Criteria for Appropriateness in a local preservation ordinance)

These are criteria that assist commissions in determining the appropriateness of actions proposed that are subject to their approval. They are usually a separate document from the preservation ordinance, but basic guidelines may be included in the code itself. In all cases, the guidelines should be associated with a set of criteria for appropriateness that are set forth in the ordinance.

Economic hardship

(Related to Takings)

The juncture at which the diminishment in value allegedly resulting from the governmental restriction on the use of the property constitutes an “unreasonable economic hardship” to the owner, which is synonymous with an unconstitutional “taking.”

Enabling legislation

Specific statements and references are found in the State Statutes of Colorado, city, town or county ordinances allowing a specific course of action with regard to historic properties and environmental settings.

Energy efficiency

One aspect of sustainable development and the conservation of resources is conserving energy. This relates to energy consumed to moderate climatic conditions in a building, but also to the manufacture and maintenance of building materials. Sensitive stewardship of the existing building stock reduces our environmental impact.

Ex parte communication

(Related to Due Process; Conflict of Interest)

Communications made to influence a decision-making official off the record and out of the presence of other parties. Ex parte communications are restricted by state and local law.

False sense of historical development

When a newly constructed building or feature imitates or replicates the style and details of a historic building, thus implying a building date that is inaccurate.

Green building

A building designed to make efficient use of physical resources and energy while minimizing its negative impacts to the environment.

Historic fabric

Original or old building materials (e.g. masonry, wood, metals, marble) or construction that make up a structure of historic significance.

Historic district

A group of buildings, properties, or sites that have been designated by one of several entities on different levels as historically or architecturally significant.

Historic property

A prehistoric or historic district, site, building, structure, or object significant in history, architecture, engineering, archaeology or culture at the national, state, or local level.

Historic significance

Importance for which a property has been evaluated and found to meet National, State or Local Register criteria

Individual landmark

Properties identified as having historic significance and formally designated to a local historic register may be listed individually

In-kind

(Related to Replacement and Repair)

A process of rehabilitation utilized only where materials are extensively deteriorated or damaged and cannot be repaired. Deteriorated materials or features are repaired with the same materials. This process is based on physical evidence of essential form and detailing of historic materials or features.

Integrity

(Related to Significance)

The retention of sufficient aspects of location, design, setting, workmanship, materials, feeling and association for a property to convey its historic significance. A majority of the resource's structural system and materials and its character-defining features should remain intact.

Local designation

(Contrast with National Register of Historic Places and State Register of Historic Properties)

A local government designates a local historic district or individual local landmark using a formal process defined in its preservation ordinance.

Motion

In a commission hearing, a statement entered into the record to approve, continue or deny an application (e.g., to designate a property "historic"). The statement must be seconded and voted upon by the commission. Motions must relate to a relevant provision of the law.

Municipal infraction

Violation of a City's code subject to a civil penalty, usually a fine. Each day of a violation can be viewed as a separate violation.

National Historic Preservation Act

National legislation (Senate Bill 3035) signed into law in 1966 intended to preserve historical and archaeological sites in the United States. The act created the National Register of Historic Places and State Historic Preservation Offices.

National Register of Historic Places

(Contrast with Local Designation)

An Individually Listed Building or those contributing to a National Register Historic District are listed in the National Register of Historic Places, the country's official list of historic properties and resources worthy of preservation. These individual buildings, structures, sites and objects are significant in American history, architecture, engineering, archaeology and culture.

Non-contributing resource in an historic district

Those properties that do not have historic significance are termed "non-contributing." The reasons for this designation could be that it is of more recent construction, it is an older property that has lost its integrity, or there is insufficient information to determine that the property has historic significance.

Open Meetings Act

Policy that public business be performed in an open and public manner, and that citizens be allowed to observe the performance of public officials and the deliberations and decisions that the making of public policy involves.

Ordinance

(May also be part of unified code)

Legislation adopted by the local governing body; a Preservation Ordinance is a part of the code specifically written to establish a preservation program, including a local commission, its powers and duties, as well as processes for designating historic resources and for reviewing proposals for work affecting them.

Preservation

(One of four recognized appropriate treatments for historic resources)

The act or process of applying measures necessary to sustain the existing form, integrity, and materials of a historic property. Work, including preliminary measures to protect and stabilize the property, generally focuses upon the ongoing maintenance and repair of historic materials and features rather than extensive replacement and new construction.

Also, in informal usage, members of the public may use this term in a broader sense, to mean any method of careful stewardship of historic resources.

Procedural due process

While local governments do have the right to regulate properties for preservation, they must do so following procedural due process. Procedural due process is based on the concept of "fundamental fairness." Procedural due process refers to the manner in which government actions are carried out, that is, the actual process of

decision-making. It requires advance notice of the proceedings, final notice of the decision reached and opportunity for individuals directly affected by the proposed governmental action to be heard.

Reconstruction

(One of four recognized appropriate treatments for historic resources)

The act or process of depicting, by means of new construction, the form, features, and detailing of a non-surviving site, landscape, building, structure, or object for the purpose of replicating its appearance at a specific period of time and in its historic location.

Rehabilitation

(One of four recognized appropriate treatments for historic resources)

The act or process of returning a property to a state that makes a contemporary use possible while still preserving those portions or features of the property which are significant to its historical, architectural and cultural values.

Restoration

(One of four recognized appropriate treatments for historic resources)

The act or process of accurately depicting the form, features, and character of a property as it appeared at a particular period of time by means of the removal of features from other periods in its history and reconstruction of missing features from the restoration period. The limited and sensitive upgrading of mechanical, electrical, and plumbing systems and other code-required work to make properties functional is appropriate within a restoration project.

Routine maintenance

Work that does not alter the exterior fabric or features of a site or structure and has no material effect on the historic, archaeological or architectural significance of the historical site or structure.

Rules of Procedure

(Related to decision making; due process)

A specific order of action which must be followed before an event (e.g., decision making). Historic Preservation Commissions establish Rules of Procedure for the disposition of applications regarding construction, alteration, reconstruction, rehabilitation, restoration, moving or demolition of a designated historic landmark, site, structure or object within a historic district.

Significance

(See Historic Significance)

Secretary of the Interior’s Standards

Specifications set by the Secretary of the Interior for the treatment of historic properties. Includes separate standards for the preservation, restoration, rehabilitation and reconstruction of historic properties.

Section 106 Review

In the National Historic Preservation Act of 1966, Congress established a comprehensive program to preserve the historical and cultural foundations of the nation as a living part of community life. Section 106 of the NHPA is crucial to that program because it requires consideration of historic preservation in the multitude of projects with federal involvement that take place across the nation every day. Section 106 requires federal agencies to consider the effects of projects they carry out, approve, or fund on historic properties. Additionally, federal agencies must provide the ACHP an opportunity to comment on such projects prior to the agency’s decision on them. Section 106 review encourages, but does not mandate, preservation. Sometimes there is no way for a needed project to proceed without harming historic properties. Section 106 review does ensure that preservation values are factored into federal agency planning and decisions. Because of Section 106, federal agencies must assume responsibility for the consequences of the projects they carry out, approve, or fund on historic properties and be publicly accountable for their decisions.

State Register of Historic Properties

A listing of the state’s significant cultural resources worth of preservation. Properties listed include individual buildings, structures, objects, districts and historic and archaeological sites. The program is administered by the Office of Archaeology and Historic Preservation within History Colorado, which maintains the official list of all properties included on the Register. Properties listed on the National Register of Historic Places are automatically placed in the Colorado State Register. They may also be nominated separately to the Colorado State Register without inclusion in the National Register.

Substantive due process

Substantive due process addresses the rationality or reasonableness of the content of a decision itself, requiring that the decision be based on the evidence on the record as applied to the standards and criteria in the ordinance. It also protects individuals from bias, conflicts of interest, and other factors bearing on the impartiality of the decision-makers.

Substitute material

A material that is used in the place of an original or existing material. In common usage, a substitute material is a newer product, usually designed to imitate the appearance of an earlier material.

Sustainability

(Related to energy efficiency and green building)

Sustainability is the managed use of resources in order to maintain the quality of life for current and future generations. It includes social, environmental and economic components. Energy conservation, which is often a topic related to preservation of historic buildings, is a component of the broader concept of sustainability and should be considered in that context.

Takings

Derives from a provision in the Fifth Amendment that states that private property shall not “be taken for public use, without just compensation.”

APPENDIX

1. Example Documents

- A. Preservation Plan Table of Contents
- B. Historic Context Introduction
- C. Completed Reconnaissance Survey Form
- D. Completed Intensive Survey Form
- E. Posting of Meeting Agenda
- F. Nomination Form
- G. Public Meeting on Establishing Historic District Agenda
- H. Designation Letter
- I. Certificate of Appropriateness Application
- J. Workshop Flyer
- K. Brochure Cover

Design Guidelines:

- L. Small Community
- M. Medium Community
- N. Large Community

- O. Annual CLG Report

A. Preservation Plan Table of Contents

TABLE OF CONTENTS

Introduction	i
The Role of The Historic Preservation Plan	ii
Plan Background	iv
What is Preservation?	v
The Sustainable Benefits of Historic Preservation	vi
A Vision for Historic Preservation in Lakewood	xi
CHAPTER 1	
Historic Resources	1-1
Historic Themes and Topics	1-1
Historic Property Types	1-11
Existing Resources	1-12
CHAPTER 2	
Program Components	2-1
Administration	2-2
Identification	2-5
Management Tools	2-6
Incentives and Benefits	2-9
Education	2-11
Advocacy and Partnerships	2-14
CHAPTER 3	
Program Goals, Policies and Actions	3-1
Priority of the Goals, Policies and Actions	3-1
Overall Goals, Policies and Actions	3-2
Administration Component	3-11
Identification Component	3-20
Management Tools Component	3-24
Incentives and Benefits Component	3-35
Education Component	3-39
Advocacy and Partnerships Component	3-46
CHAPTER 4	
Implementation	4-1
Phasing Criteria	4-1
Implementation Table	4-3

Document Notes

Table of Contents from the City of Lakewood, CO Historic Preservation Plan
Winter & Company, July 2012

B. Historic Context Introduction

Historic Context and Survey of Post-World War II Residential Architecture, Boulder, Colorado

1.0 INTRODUCTION

Following World War II, Boulder experienced a population surge that quickly transformed the small university town of 12,958 residents in 1940 to a lively city of 72,000 residents by 1972. With 12 million returning servicemen and women nationwide, the postwar boom caused a desperate housing shortage that initiated a wave of construction that radically impacted every aspect of the nation, including Boulder. Interstate highways, roads, shopping centers, and vast expanses of residential subdivisions altered the landscape and expanded Boulder's city boundaries in all directions. Fueled by urgency and expediency, developers and builders created new housing developments on former farmland on the city's outer fringes. The architecture and design of the new housing and its neighborhoods were markedly different from those built before the war. They emerged in the form of Ranch, Split-Level, and Bi-Level houses set on curving roads and cul de sacs, and provided house-hungry buyers a place to call home and start a family.

Since the end of the postwar era, popular architectural trends in housing have continued to evolve, and now postwar housing stands out for its own architectural merits. House types like the Ranch and the Split-Level are being recognized for their significant departure from prewar housing, while the vast acreage devoted to postwar subdivisions at the outer edges of the cities permanently impacted the American landscape. Today, as many of these houses remain in place and continue to provide housing for Boulder's populace, redevelopment pressures encourage major alterations and demolition. As a result, intact, unaltered postwar houses and subdivisions are becoming a disappearing resource in Boulder.

Few states and cities, including Colorado and its municipal districts, have undertaken historic studies of their postwar housing subdivisions and other residential developments constructed during the late 1940s, 1950s, and 1960s. This is partially due to the relatively recent age of resources built after 1945, and because architectural surveys are typically completed only for buildings and structures that have turned 50 years of age; the threshold in which all buildings are evaluated under standard National Register of Historic Places (National Register) criteria (National Park Service 1997). The City of Boulder has surveyed the majority of its buildings constructed prior to 1947, but has little analysis on its residential subdivisions dating from the postwar years. In 1999-2000, the City of Boulder undertook a city-wide survey of Modern architecture built between 1947 and 1977 to examine its individual, custom-designed residential, commercial, and public buildings that express a variety of Modern architectural styles and building types (Paglia, Segel, and Wray, 2000). This report has a different focus from this previous study by studying only postwar residential subdivisions, which differ from their custom-designed residential counterparts because they are builder-driven, mass-produced groupings of a limited number of house models and often are marketed to a different demographic as well. The

7

Document Notes

Introduction to Historic Context and Survey of Post-World War II Residential Architecture, Boulder, CO, TEC Inc., April 2010

B. Historic Context Introduction

Historic Context and Survey of Post-World War II Residential Architecture, Boulder, Colorado

housing types examined here are also not limited to Modern architectural styles or building types, while the previous examined avant garde approaches to the Modern Movement in the city. This study examined a number of additional factors and influences that make postwar residential subdivisions and housing different from other types of architectural resources.

A second reason for the lack of postwar housing inventories is that the vast number of buildings makes intensive survey a daunting prospect to many cities and towns that have literally thousands of these resources. As large-scale building activities met an urgent demand during the early postwar housing crunch, efficient construction methods resulted in uniformity of design, form, and landscape characteristics. Many residential subdivisions contained hundreds of houses built from only a handful of architectural plans or models. This uniformity of design and architectural form, and landscape characteristics requires a different approach from traditional survey methods. It also allows an opportunity to explore more efficient survey methods that emphasize the significance of a subdivision as a whole, as well as the individual components of that subdivision. These considerations informed the approaches and methods of the historic context and survey results presented in this report.

This project constitutes the first in-depth study of postwar housing in Boulder. Informed by primary and secondary research, oral history interviews, field survey, and analysis of historic significance; it consists of a historic context theme and a selective intensive survey of 105 representative housing types in Boulder from the period between 1947 and 1967. The purpose of this study is to identify and evaluate housing types and subdivisions from that period, to educate and inform the community about postwar residential architecture in Boulder, and where appropriate, make recommendations to the City of Boulder for the management of identified potentially significant resources.

This report is organized into eight chapters, including Chapter 1, Introduction. Chapter 2 describes the total acreage and legal locations of the study area and selective survey. It includes one overview map of Boulder and 10 maps depicting each of the ten postwar subdivisions investigated, color-coded by each parcel's approximate date of construction.

The study's Research Design and Methods are presented in Chapter 3. This chapter describes the project's windshield survey and reconnaissance survey that led to the identification of the resources included in the selective survey within each of the ten subdivisions studied. This selective inventory consists of 105 examples of postwar housing types within the subdivisions of Baseline, Edgewood, Flatirons Park, Highland Park, Interurban Park, Martin Acres, Park East, Sunset Hills, Table Mesa, and Wagoner Manor. Chapter 3 also describes the resources and materials used to prepare the historic context of postwar housing in Boulder, and the approaches developed to undertake the intensive survey.

8

Document Notes

Introduction to Historic Context and Survey of Post-World War II Residential Architecture, Boulder, CO, TEC Inc., April 2010

B. Historic Context Introduction

Historic Context and Survey of Post-World War II Residential Architecture, Boulder, Colorado

Chapter 4 presents the National Historic Context, which is an essay on the historic background of the architectural, social, and physical environment in which the post-World War II residential neighborhoods unfolded in the United States. While this report focuses on the period of residential construction between the years 1947 and 1967, the historic context encompasses the broader historic setting in which new ideas, construction technology, and architectural types emerged leading up to and encompassing the postwar era of the late 1940s through the 1970s. Examination of national trends concerning urban planning, transportation development, residential construction, and architectural movements illuminates Boulder's relationship with national patterns and influences that impacted the city during this period.

A historic context of Boulder is located in Chapter 5 and focuses on the growth and development of Boulder leading up to and encompassing the postwar period. Included is historic research concerning patterns of development, commonly found housing types, and other influencing factors on residential development unique to Boulder. This context includes a history of each of the ten neighborhoods surveyed during this project.

Architectural descriptions of the housing types that were observed and analyzed during survey and evaluations are presented in Chapter 6. These housing types and/or architectural forms serve as a guide and supplement to the intensive survey analysis, results, and Architectural Inventory Forms completed for the Intensive Selective Survey.

Chapter 7 presents the results of the selective survey of 105 representative housing types in the ten neighborhoods surveyed. Informed by research data and intensive-level fieldwork, evaluations of architectural and historic significance were made for each of the 105 properties in the selective survey. Evaluations were made in accordance with the National Register Criteria for eligibility and with local landmark eligibility criteria set forth by the City of Boulder. These evaluations include historic district eligibility for the National Register and local historic districts, where appropriate. The recommendations presented in Chapter 7 are intended to provide the City of Boulder with suggestions as to how findings of the study may be used to manage buildings and areas of historic, architectural, or environmental significance. This chapter also suggests alternative management techniques and or/criteria for evaluation to preserve the character of identified areas of significance and potential eligibility within the City of Boulder.

Document Notes

Introduction to Historic Context and Survey of Post-World War II Residential Architecture, Boulder, CO, TEC Inc., April 2010

B. Historic Context Introduction

Historic Context and Survey of Post-World War II Residential Architecture, Boulder, Colorado

Appendix A is the Survey Log of the selective intensive survey data and findings, organized both by address and by site number.

Appendix B is a research database of Builders and Models Research Data, Housing Types by Subdivision, City Directory Records, and Subdivision Filing Dates.

Appendix C is a table of black-and-white photographs scanned from the City of Boulder's Assessor Records archived at the Carnegie Branch Library for Local History, of the Boulder County Public Library system. These photographs illustrate the original appearance of many of the properties intensively surveyed in this study.

Appendix D is a compilation of newspaper advertisements scanned from The Daily Camera newspaper. These advertisements are organized by surveyed subdivision (as available) while the remaining ads are grouped by builder, or by other subdivisions noted but not surveyed in this study.

Appendix E is a timeline of the major historical events in Boulder between 1859 and 1971.

TEC Inc. prepared this report under a contract with the City Boulder. Preparers include Jennifer E. Bryant, Historian; and Carrie Schomig, Architectural Historian; with assistance from Marcy Cameron, Field Assistant; Melissa Johnson, GIS Specialist; and Allison Parrish, Field Assistant. Contributors to this effort include the City of Boulder Historic Preservation Planners James Hewat and Chris Meschuk, and Tim Plass, Chair of Boulder's Landmark Preservation Advisory Board. TEC Inc. would also like to thank the librarians and research staff of the Carnegie Branch Library for Local History, of the Boulder County Public Library system.

Document Notes

Introduction to Historic Context and Survey of Post-World War II Residential Architecture, Boulder, CO, TEC Inc., April 2010

C. Completed Reconnaissance Survey Form

COLORADO CULTURAL RESOURCES INVENTORY

Greeley 8th Avenue Survey

Historical and Architectural Reconnaissance Form

IDENTIFICATION

1. Current Property Name: **Randy Premer Auto Repair**
Historic Property Name **Ray & Gus Independent Gas, Seery's Service Station Building**
2. Resource Classification: **Building**
3. Ownership: **Private**
Owner(s) contact info: **Randolph L. Premer, Colleen K. Premer**
1300 8th Avenue
Greeley, CO 80631

LOCATION

4. Street Address: **1300 8th Avenue**
5. Municipality: **Greeley, Colorado**
6. County: **Weld**
7. USGS Quad (7.5'): **Greeley, Colorado** year: **1950** Photorevised **1980**
8. Parcel Number: **096108214001**
9. Parcel Information: Lot(s): **4** Block: **103** Addition: **Greeley Original Townsite**
10. Acreage: **< 1 (7125 square feet)**
11. PLSS information: Principal Meridian: **6th** Township: **5 North** Range: **65 West**
SE¼ SW¼ NE¼ NW¼ of section **8**
12. Location Coordinates: **Zone 13** **526261 mE** **4474187 mN**
Datum: **NAD83**

DESCRIPTION

13. Construction features (forms, materials)
 - Property Type: **One Story Commercial Building**
 - Building Plan: **Rectangular Plan**
 - Dimensions in Feet: **2250 square feet**
 - Stories: **One**
 - Architectural Style/Type: **Modern Movements / Oblong Box Gas Station**
 - Foundation: **Concrete**
 - Walls: **The west-facing (façade) wall and the north-facing wall are made of brown brick laid in running bond, accented with a wide band of red brick at the bottom and a narrow stringcourse of red brick at a level above the door and window openings.**

OAHF Site #: **5.WL.7865**

Eligibility Evaluation (OAHF use only)

Date _____ Initials _____

___ Determined Eligible – NR

___ Determined Eligible - SR
___ Needs Data

___ Eligible District – Contributing

___ Eligible District - Noncontributing

Document Notes

Completed Reconnaissance Survey for 1300 8th Avenue in Greeley, CO as part of the Greeley 8th Avenue Survey

C. Completed Reconnaissance Survey Form

OAHP Site #: 5.WL.7865

- The north end of the east-facing (rear) wall is made of brown brick, but without the red brick accents. The remainder of the east-facing wall and the south-facing wall are made of grey brick laid in common bond.
- Windows: Single-light display windows in silver metal frames flank the entry into the customer service office at the north end of the façade. A 2-light display window is located just around the corner at the west end of the north-facing wall. The south-facing wall contains two small 3-light hopper industrial sash windows with brown brick rowlock sills.
- Roof: The roof is flat, decorated along the west and north sides, with an applied faux roof eave clad with brown asphalt composition shingles. Advertising signs for "UNIROYAL" and "MICHELIN" are attached to the east-facing (façade) eave.
- Chimney(s): N/A
- Porch(s) / Doors: A glass-in-silver-metal-frame door enters into the customer service office from within a slightly recessed entryway near the north end of the façade. The southern portion of the façade contains four painted beige color wood-paneled rollaway garage service bay doors. These garage bay doors are separated by brown brick columns with red brick accents. The east end of the north-facing wall contains two doors which enter into restrooms, respectively labeled "LADIES" and "MEN." Both of these doors are painted cream yellow, wood-paneled, with frosted glass upper sash lights and with frosted glass transom lights.

14. Landscape (important features of the immediate environment)

- Garden Mature Plantings Designed Landscape Walls Parking Lot
- Driveway Sidewalk Fence Seating

HISTORICAL ASSOCIATIONS

15. Historic function/use: **Commerce/Trade / Gas Station**
 Current function/use: **Commerce/Trade / Specialty Store (automobile repair facility)**
16. Date of Construction: **Circa 1954 (per city directories, Sanborn maps, and Assessor records)**
17. Other Significant Dates: **N/A**
18. Associated NR Areas of Significance
- | | | | | |
|---|--|--|--|--|
| <input type="checkbox"/> Agriculture | <input checked="" type="checkbox"/> Architecture | <input type="checkbox"/> Archaeology | <input type="checkbox"/> Art | <input checked="" type="checkbox"/> Commerce |
| <input type="checkbox"/> Community Planning & Development | <input type="checkbox"/> Conservation | <input type="checkbox"/> Economics | <input type="checkbox"/> Education | <input type="checkbox"/> Engineering |
| <input type="checkbox"/> Entertainment/Rec. | <input type="checkbox"/> Ethnic Heritage | <input type="checkbox"/> Exploration/Settlement | <input type="checkbox"/> Health/Medicine | <input type="checkbox"/> Industry |
| <input type="checkbox"/> Invention | <input type="checkbox"/> Landscape Architecture | <input type="checkbox"/> Law | <input type="checkbox"/> Literature | <input type="checkbox"/> Maritime History |
| <input type="checkbox"/> Military | <input type="checkbox"/> Performing Arts | <input type="checkbox"/> Philosophy | <input type="checkbox"/> Politics/Gov't. | <input type="checkbox"/> Religion |
| <input type="checkbox"/> Science | <input type="checkbox"/> Social History | <input checked="" type="checkbox"/> Transportation | <input type="checkbox"/> Other | |
19. Associated Historic Context(s) (if known): **City of Greeley 8th Avenue Survey; Greeley Downtown Historic District**
20. Retains Integrity of: Location Setting Materials Design Workmanship Association Feeling

Document Notes

Completed Reconnaissance Survey for 1300 8th Avenue in Greeley, CO as part of the Greeley 8th Avenue Survey

C. Completed Reconnaissance Survey Form

OAHP Site #: 5.WL.7865

21. Notes:

This building is located at the southeast corner of 8th Avenue and 13th Street. It was built circa 1954, replacing the Swedish Evangelical Lutheran Immanuel Church which had occupied the site since circa 1908. Asphalt and concrete parking lots / driveways surround the building, except near the rear northeast corner where there is a small area of planted grass.

22. Sources:

The Greeley City and Rural Route Directory. (Generally published annually by *the Greeley Tribune-Republican Publishing Company*.)

Sanborn Insurance Company maps for Greeley, Colorado dated June 1886, December 1887, January 1891, October 1895, January 1901, January 1906, October 1909, January 1918, April 1927, September 1946 (as an update of the April 1927 Sanborn maps), August 1968 (also as an update of the April 1927 Sanborn maps).

Weld County Assessor Property Information Map. <http://www.co.weld.co.us/maps/propertyinformation>

Weld County Assessor Property reports. <https://propertyreport.co.weld.co.us>

FIELD ELIGIBILITY RECOMMENDATIONS

Local Landmark Eligible? yes no needs data

Individually State Register Eligible? yes no needs data

Individually National Register Eligible? yes no needs data

Contributes to a Potential Historic District? yes no needs data property is not located within a potential district

RECORDING INFORMATION

Recorded by:	Carl McWilliams	Date:	November 30, 2015
Affiliation/Organization:	Cultural Resource Historians LLC	Phone Number:	(970) 493-5270
Report title:	City of Greeley 8 th Avenue Survey		
Project Sponsor:	City of Greeley Historic Preservation Office		
Photo Log:	CD 1, Images 216 CD 2, Images 1-3		

History Colorado – Office of Archaeology and Historic Preservation
1200 Broadway, Denver, Colorado 80203
303-866-3395

Document Notes

Completed Reconnaissance Survey for 1300 8th Avenue in Greeley, CO as part of the Greeley 8th Avenue Survey

C. Completed Reconnaissance Survey Form

OAHP Site #: 5.WL.7865

SKETCH PLAN

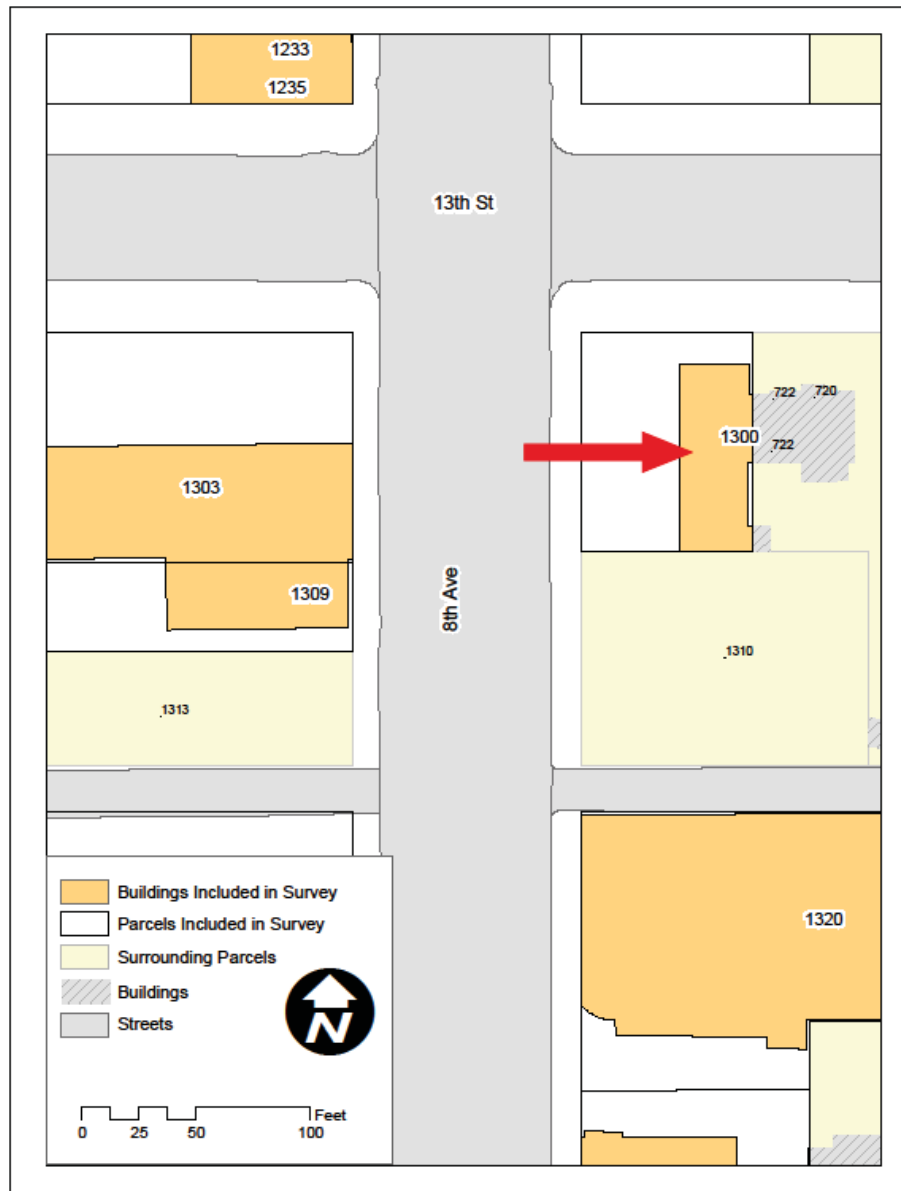

Document Notes

Completed Reconnaissance Survey for 1300 8th Avenue in Greeley, CO as part of the Greeley 8th Avenue Survey

C. Completed Reconnaissance Survey Form

OAHP Site #: 5.WL.7865

LOCATION MAP

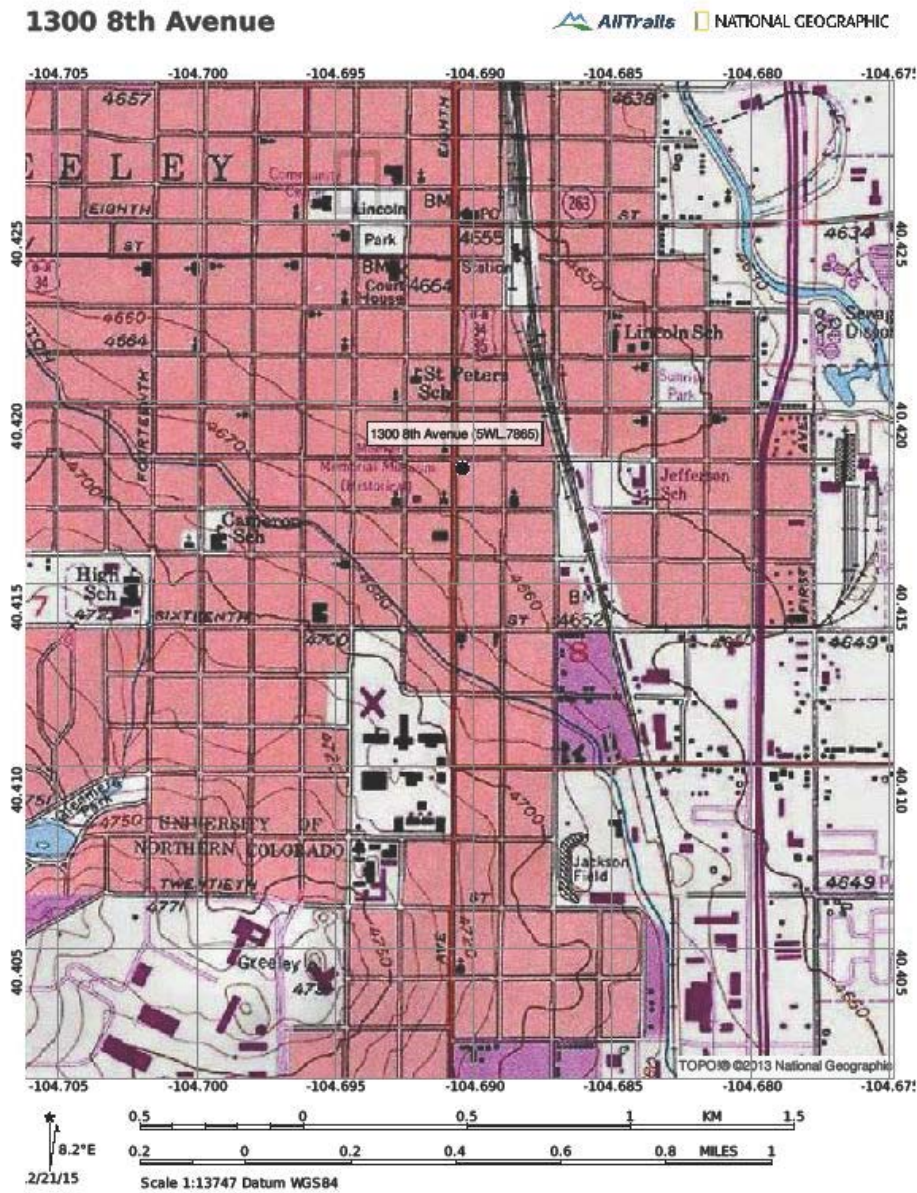

Document Notes

Completed Reconnaissance Survey for 1300 8th Avenue in Greeley, CO as part of the Greeley 8th Avenue Survey

C. Completed Reconnaissance Survey Form

OAHP Site #: 5.WL.7865



CD 2, Image 1, View to NE of façade (west) and south side



CD 1, Image 2, View to SE of façade (west)

Document Notes

Completed Reconnaissance Survey for 1300 8th Avenue in Greeley, CO as part of the Greeley 8th Avenue Survey

C. Completed Reconnaissance Survey Form

OAHP Site #: 5.WL.7865



CD 2, Image 3, View to SW of north side and rear (east)

Document Notes

Completed Reconnaissance Survey for 1300 8th Avenue in Greeley, CO as part of the Greeley 8th Avenue Survey

D. Completed Intensive Survey Form

OAHP 1403
Rev. 9/98

COLORADO CULTURAL RESOURCE SURVEY

Architectural Inventory Form

Page 1 of 5

Official Eligibility Determination
(OAHP Use Only)

Date _____ Initials _____
_____ Determined Eligible-NR
_____ Determined Not Eligible-NR
_____ Determined Eligible-SR
_____ Determined Not Eligible-SR
_____ Need Data
_____ Contributes to Eligible NR District
_____ Noncontributing to Eligible NR District

I. IDENTIFICATION

- 1. **Resource Number:** 5WL.7990
- 2. **Temporary Resource Number:** N/A
Parcel Number: 146718321008
SHF/CLG Grant Number: 16-M1-005
Temp. Survey Number: 6
- 3. **County:** Weld
- 4. **City:** Erie
- 5. **Historic Building Name:**
Bailey House
- 6. **Current Building Name:**
Romero House



- 7. **Building Address:** 300 Holbrook Street, Erie
- 8. **Owner Name and Address:** Raymond V. and Raymond Vincent Romero, 13352 Allcott St., Broomfield, CO 80020

II. GEOGRAPHIC INFORMATION

- 9. **P.M.** 6th **Township** 1 N **Range** 68 W
SW 1/4 SW 1/4 NE 1/4 SW 1/4 of Section 18
- 10. **UTM Reference(s):** Zone 13, 495693, 4432863
- 11. **USGS Quad Name:** Erie, Colo. **Year:** 1967 (PR1979) **Map Scale:** 7.5'
- 12. **Lot (s):** 1-2 **Block(s):** 34
Addition: West Addition to Erie **Year of Addition:** 1883
- 13. **Boundary Description and Justification:**
Boundary includes the building and the parcel on which it is located.

III. ARCHITECTURAL DESCRIPTION

NOTE: For complexes, Items 14 through 22 apply only to Resource 1.

- 14. **Building Plan (footprint, shape):** Rectangular
- 15. **Dimensions in Feet: Length** 32 **X Width** 24
- 16. **Stories:** 1
- 17. **Primary External Wall Material(s) (enter no more than two):**
Wood/Horizontal Siding
- 18. **Roof Configuration (enter no more than one):**
Gabled/Side Gabled
- 19. **Primary External Roof Material (enter no more than one):** Wood/Shingle

Document Notes

Completed Intensive Survey form for 300 Holbrook Street in Erie, CO

D. Completed Intensive Survey Form

Resource Number: 5WL.7990

Architectural Inventory Form

Page 2 of 5

20. Special Features (enter all that apply):

Porch, Chimney, Fence

21. General Architectural Description:

This one-story frame house (Resource 1) faces east and has a side-gabled roof with wood shingles and overhanging eaves; there is a metal pipe chimney on the roof. The walls are clad with weatherboard siding with corner boards, and a concrete collar projects along the foundation.

A center entrance on the front (east) wall is sheltered by a curving metal hood and has a paneled wood door with a fanlight and an older metal screen door. A low concrete stoop with pieces of flagstone on its top is in front of the entrance. Flanking the entrance are tall four-over-four-light double-hung sash windows with plain wood surrounds.

The south wall is blank at the east end and has a tall two-part replacement window farther west, an entrance with a paneled door and metal screen facing a low concrete stoop, and a four-over-four-light wood window farther west. The rear (west) wall is unfenestrated and has a small, projecting enclosed porch toward the north end. The north wall displays from west to east: a short wood one-over-one-light window, a four-over-four-light wood window, an entrance with a wood paneled and glazed door with a metal screen door, and a four-over-four-light window.

22. Architectural Style/Building Type: Late Victorian/Queen Anne

23. Landscaping or Special Setting Features:

Planting beds formed by low stone retaining walls are on each side of the east entrance of the main house. Old evergreen shrubs grow in the planting beds, and a large tree is in front of the south bed. The front yard is in grass and has a sidewalk composed of pieces of flagstone leading to the entrance. A very large tree stump is at the northeast corner of the yard, with a smaller tree near it. A chainlink fence along the south is set in from the concrete sidewalk. A vertical board fence divides the yards of the two houses. The second house has a small patio composed of stone pavers on the south. There is a wood privacy fence along the north property line.

24. Associated Buildings, Features, or Objects:

2. Second House, 435 Anderson St., 1932 (inscribed date). A second house on the parcel faces south and is composed of painted concrete block. The house has a front gabled roof with overhanging eaves and composition roofing. The south wall contains a paneled door to the east and a one-over-one-light window to the west. The west wall has a one-over-one-light window near the north end. The east wall has two similar windows. Near the northeast corner of the house in the concrete sidewalk is etched "A.H. Feb 22, 1932." Although the assessor reported an 1890 year built for this dwelling, given its concrete block construction and inscribed date, 1932 seems more likely.

3. Shed, post-1966. A small gabled roof metal shed behind the house faces east and has ribbed metal walls and roofing. The shed has a double door entrance with one door missing. A concrete, wood board, and stone sidewalk leads to the shed

4. Shed, post-1966. A front gabled roof rectangular shed faces west and has unpainted horizontal board siding on the walls and vertical board siding on the gable faces. The shed has an off-center door and a window on the west wall and a one-over-one-light double-hung window on the south.

IV. ARCHITECTURAL HISTORY

NOTE: For complexes, Items 25 through 30 apply only to Resource 1.

25. Date of Construction: Estimate 1890 Actual

Source of Information: Weld County Assessor

26. Architect: Unknown

Source of Information:

27. Builder/Contractor: Unknown

Source of Information:

28. Original Owner: William Bailey

Source of Information: Ownership records and construction date

29. Construction History (include description and dates of major additions, alterations, or demolitions):

The Weld County Assessor reports an estimated construction date of 1890 for the main house, although the house may date to the late 1880s based on the first owner's property acquisition date. The property appears on the 1948

Document Notes

Completed Intensive Survey form for 300 Holbrook Street in Erie, CO

D. Completed Intensive Survey Form

Resource Number: 5WL.7990

Architectural Inventory Form

Page 3 of 5

Sanborn map only, which shows the main dwelling, with two small outbuildings (now gone) immediately behind it. A small second dwelling (estimated date 1932) with a garage attached at the rear is in the location of the current second dwelling. The attached garage is gone, as is a rectangular shed perpendicular to the garage. The current two sheds appear to be nonhistoric.

30. Original Location: Yes Date of Moves: N/A

V. HISTORICAL ASSOCIATIONS

31. Original Use(s): Domestic/Single Dwelling

32. Intermediate Use(s): Domestic/Single Dwelling

33. Current Use(s): Domestic/Single Dwelling

34. Site Type(s): House

35. Historical Background:

The Baileys. The records of Heritage Title Co. in Greeley indicate that in 1885 Sidney Dillon (affiliated with the Union Pacific Railroad) sold this property to William Bailey, who transferred it to his wife Sarah two years later. The Baileys were the original owners and builders of this house. The assessor's estimated year of construction is 1890, but the house could have been built earlier based on the Baileys' purchase of the land. William, a farmer and coal miner born on 24 May 1854 in England, immigrated to the United States in 1882; he became a naturalized citizen. About 1874 in England William had married Sarah Wotherspoon Grimson, a Scottish widow born in March 1844. The following year their first child, daughter Harriet, was born in Durham, England, followed by James, Mary Jane, and Alexander. William's wife and family, including children born in Scotland from Sarah's first marriage, came to America about 1883. The couple may have been living in Erie soon after. The 1885 Colorado Census found them there, where William was a coal miner. In addition to their children, the Bailey household included three members of the Heaton family who boarded with them.

The 1900 U.S. Census found the Baileys living in Snyder, Morgan County, Colorado, where William worked as a farmer. Living with the couple were several of their children: James (22, born in England, and working as a farm laborer), Isabella "Belle" (32, born in Scotland in Sarah's first marriage), Alexander (18, born in England, and working as a farm laborer), and William (15, born in Colorado, a student). Belle's two children, Alice and Joseph Oats, also lived in the household. Sarah indicated she had given birth to nine children during her life; a daughter, Margaret Grimson, died in 1900 and a son, John Grimson, passed away in 1908. John Grimson, born in Scotland in 1866 came with the family to the United States. He and his wife, Mary, were parents of eight children. He was rescued after a cave-in at the Lehigh Mine, but died from injuries he sustained in a second accident. Mary's three brothers were killed in an explosion at the Schofield Mine in Utah in 1900.

By 1910 the U.S. Census recorded the Baileys living in Erie at this house. At that time William Bailey was a coal miner. Also living with the couple that year was 40-year-old William Grimson, Sarah's son from her first marriage. William Grimson was born about 1870 in Scotland, immigrated in 1883, and worked as a farm laborer. In 1920 the three adults still lived in the house, with William Bailey retired by that year and William Grimson working as an engineer at a coal mine. In June 1927 William Bailey died at age 73 at his home in Erie. A notice of his death in the Longmont Daily Times stated "Mr. Bailey came to Erie in 1884 and is exceptionally well known in that district." Sarah Bailey also died in 1927, and the couple shares a gravestone in Mount Pleasant Cemetery.

The Heaton family. In 1929 Andrew Heaton (whose sister-in-law, Harriet Grimson Heaton, was a daughter of William and Sarah Bailey) acquired this property from the couple's estate. Andrew was born about 1866 in England and worked as a coal miner. Previously he lived with his brother, Anthony Heaton and sister-in-law, Harriet, at 404 Holbrook. By 1940 Andrew Heaton lived alone on West Erie Street. In 1942 Harriet Heaton acquired this property from Andrew Heaton. On a previous survey form for this property, June Lewis of Erie indicated that the Heaton family built the Alpine Hall in town. Anthony and Sarah Heaton were born in England (he in Lancaster in 1866, and she in Durham in 1875); she came to the U.S. with her parents in 1882 and he in 1885. They became naturalized American citizens. Harriet was the daughter of William and Sarah Bailey, who lived at 300 Holbrook.

Anthony and Harriet married in 1893 in Akron, Colorado. They and their two children (William and Mary) were recorded in the 1900 U.S. Census in Erie, where Anthony was a coal miner. The Heaton family was mentioned in the Erie News as early as 1903, but a March 1905 article noted, "Anthony Heaton moved to Hillrose, Colorado, last Friday. Mr. Heaton expects to engage in ranching at that point." It appears he had been and continued to be involved in mining; a June 1905 edition of the Erie News noted Anthony Heaton was president of Local Union No. 1417, United Mine Workers of America.

Document Notes

Completed Intensive Survey form for 300 Holbrook Street in Erie, CO

D. Completed Intensive Survey Form

Resource Number: 5WL.7990

Architectural Inventory Form

Page 4 of 5

At the time of the 1910 Census, the Heaton's lived in Canfield, Boulder County, with Anthony working as a farmer. By that date the Heaton's had been married for 17 years and had 4 children: William (15), Mary (11), Margery (6), and Elvira (3). When the Heaton's moved back to Erie and bought this house in 1910, Anthony reentered the coal mining business, working by 1920 as a coal mine "timber man." By that time the Heaton's had 7 children living with them, ranging from 25-year-old William B. Heaton, a coal mine motor man, to four-year-old Clarence.

In September 1927, the Daily Times of Longmont named Anthony Heaton one of several local men who would be helping to drive school buses in Erie. Also in 1927, the Daily Times ran an article announcing the death of Harriet Heaton's mother, 80-year-old Scottish immigrant Mrs. Sarah Bailey, who had been a resident of Erie since 1882. At the time of the 1930 U.S. Census, sixty-three-year-old Anthony worked as a coal miner. In that year four children still lived at home: Elvira, a 22-year-old operator at the telephone exchange; 19-year-old Anthony, a truck line driver; 17-year-old James; and 15-year-old Clarence. Anthony's brother, 64-year-old Andrew Heaton, a widowed coal miner, also lived with them, as did Harriet's 60-year-old brother, William Grimson, a naturalized Scottish immigrant who was proprietor of a gas wholesale station. In 1944 Harriet Heaton sold this property and moved to Los Angeles with her husband and brother. She died there in 1949 and Anthony passed away there in 1953.

Later Owners. In 1944 August and Andrea Moya bought the house. By the 1940 Census, they were already living in a house on Holbrook Street in Erie owned by August's father, John. August was born in Colorado about 1900 and worked as a hand loader in a coal mine. Andrea was born about 1901, also in Colorado. August and Andrea's children lived with them: Teter, Albina, Fred, and Rosie. Albina was employed doing housework for a private family. August Moya died in June 1970 and is buried in Mountain View Memorial Park in Boulder.

Mary Alvina Abeyta became owner of the house the following year. She was born in 1924, died in 2013, and is buried in Lafayette Cemetery. Her husband was Gilbert F. Abeyta (1922-78). Theodora Abeyta became the home's owner in 1959. The Abeytas do not appear in the 1961 or 1964 Weld County directories. In 1989 Mrs. Alvina Maria Bueno acquired the property. The current occupant of the property reported that Mrs. Bueno lived here as a little girl. Her son, Raymond Vincent Romero of Broomfield, is the current owner.

36. Sources of Information:

Heritage Title Co., Greeley, Subdivision Tract Books; Weld County Assessor records; U.S. Census, 1870-1940; findagrave.com; Daily Times (Longmont), 9 July 1927; William Bailey family tree, ancestry.com; Sarah Wotherspoon family tree, ancestry.com; Weld County directories, 1961 and 1964; U.S. Social Security Death Index; Sanborn Map Co., fire insurance map, 1948; James B. Stull, A Brief History of Erie: Out of the Coal Dust (Charleston, South Carolina: The History Press, 2015), 22.

VI. SIGNIFICANCE

37. Local Landmark Designation: No Date of Designation: N/A

Designating Authority: N/A

Applicable State Register of Historic Properties Criteria:

- A. The property is associated with events that have made a significant contribution to history.
- B. The property is connected with persons significant in history.
- C. The property has distinctive characteristics of a type, period, method of construction or artisan.
- D. The property has geographic importance.
- E. The property contains the possibility of important discoveries related to prehistory or history.
- Does not meet any of the above State Register criteria.

State Register Field Eligibility Assessment Eligible

38. Applicable National Register Criteria:

- A. Associated with events that have made a significant contribution to the broad pattern of our history.
- B. Associated with the lives of persons significant in our past.
- C. Embodies the distinctive characteristics of a type, period, or method of construction, or represents the work of a master, or that possesses high artistic values, or represents a significant and distinguishable entity whose components may lack individual distinction
- D. Has yielded, or may be likely to yield, information important to history or prehistory.
- Qualifies under Criteria Considerations A through G, as specified:

Document Notes

Completed Intensive Survey form for 300 Holbrook Street in Erie, CO

D. Completed Intensive Survey Form

Resource Number: 5WL.7990

Architectural Inventory Form

Page 5 of 5

Does not meet any of the above National Register criteria.

National Register Significance: Area, Period, and Level:

39. Area(s) of Significance: Architecture **40. Period(s) of Significance:** ca. 1890 **41. Level(s) of Significance:** Local

42. Statement of Significance:

This house is potentially eligible to the National and State Registers at a local level of significance for its architecture, representing a well preserved nineteenth-century home of a large coal mining family during the period when the industry dominated Erie's economy. The first and longtime owners and occupants of the house, William and Sarah Bailey, were British immigrants who lived here with their children and various members of their extended family who were importantly associated with the history of coal mining in Erie. The house was owned by members of the Bailey family for more than half of a century. The small scale, frame construction with weatherboard siding, simple vernacular design with a symmetrical façade, and tall four-over-four-light double-hung sash windows testify to the architectural tastes, economic status, and lifestyles of the town's early mining families.

43. Assessment of Historic Physical Integrity Related to Significance:

This circa 1890 house displays substantial historic physical integrity with minor alterations, including a metal pipe chimney, a replacement window, and a replacement front door. The house retains most of its historic windows, its original wood siding, design, fenestration, massing, location, setting, feeling, and association as the family home of people associated with coal mining.

VII. NATIONAL REGISTER ELIGIBILITY ASSESSMENT

44. National Register Field Eligibility Assessment: Eligible

45. Is there National Register district potential? Discuss. Unknown

This building was documented as part of a selective intensive survey. Other buildings in the immediate area were not surveyed. District potential is unknown.

If there is NRHP district potential, indicate contributing status: N/A

46. If the building is in an existing NRHP district, indicate contributing status: N/A

VIII. RECORDING INFORMATION

47. Digital Image Reference(s): WL7984-01 to -10

Digital Images Filed At: Erie Town Clerk

Photographer: T.H. Simmons

48. Report Title: Erie, Colorado, Historic Buildings Survey, 2016

49. Date(s): Jan. 2016

50. Recorder(s): R.L. Simmons/T.H. Simmons

51. Organization: Front Range Research Associates, Inc.

52. Address: 3635 W. 46th Ave., Denver, CO 80211

53. Phone Number(s): (303) 477-7597

NOTE: Please attach a sketch map, a photocopy of the USGS quad map indicating the resource's location, and photographs.

**History Colorado-Office of Archaeology and Historic Preservation
1200 Broadway, Denver, Colorado 80203 (303) 866-3395**

Document Notes

Completed Intensive Survey form for 300 Holbrook Street in Erie, CO

D. Completed Intensive Survey Form

Resource Number: 5WL.7990
Temporary Resource Number: N/A

Architectural Inventory Form

SKETCH MAP: 300 Holbrook Street

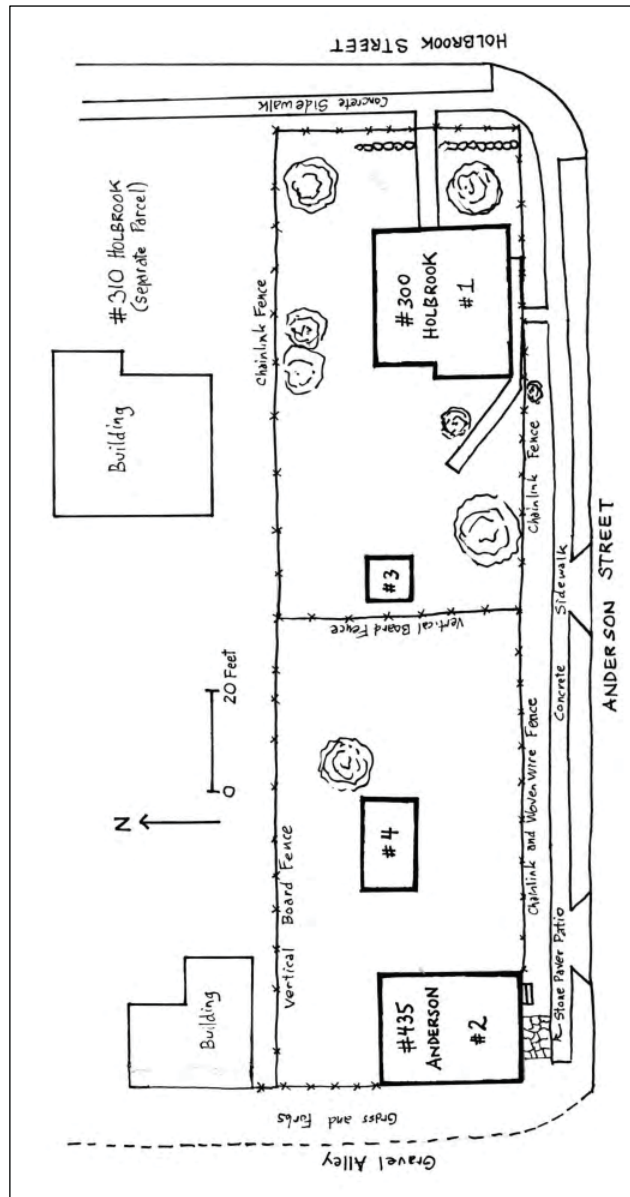

Document Notes

Completed Intensive Survey form for 300 Holbrook Street in Erie, CO

D. Completed Intensive Survey Form

Resource Number: 5WL.7990
Temporary Resource Number: N/A

Architectural Inventory Form
USGS Location Map

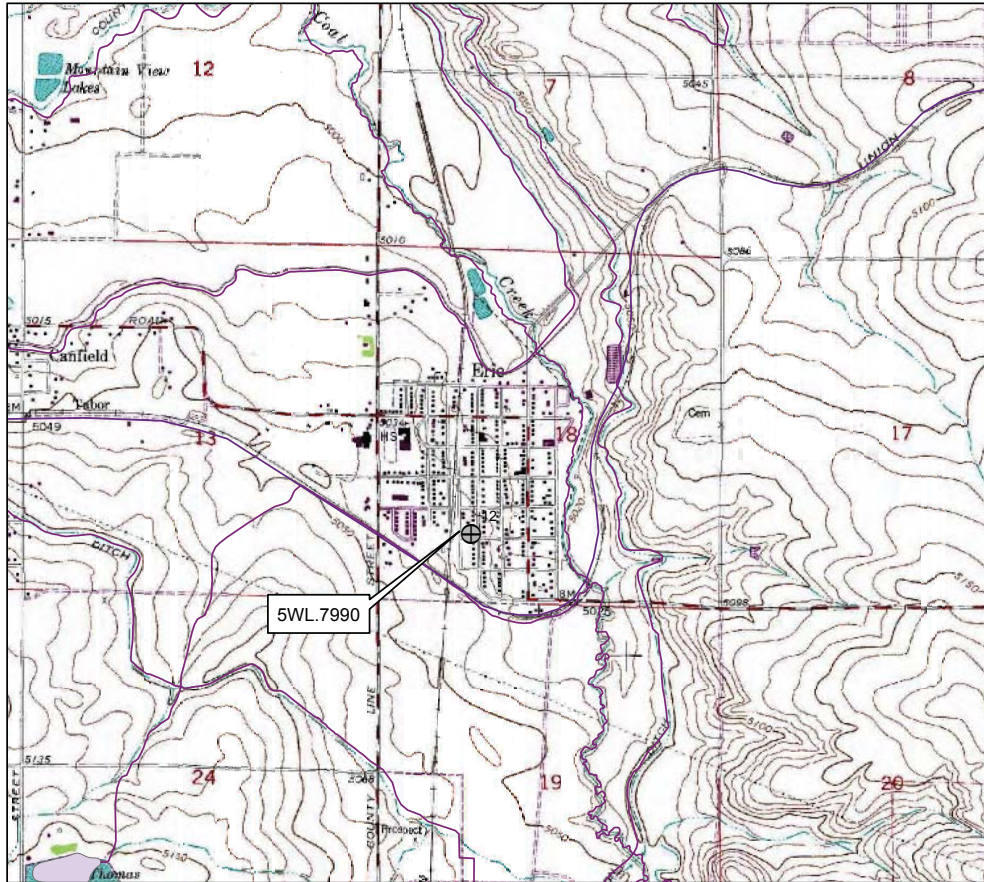

300 Holbrook Street, Erie, Colorado



0 2,000 Feet



SOURCE: Extract of Erie, Colo.,
USGS map, 1967 (PR 1979). Crosshair
shows location of surveyed resource.

Document Notes

Completed Intensive Survey form for 300 Holbrook Street in Erie, CO

D. Completed Intensive Survey Form



Document Notes
Completed Intensive Survey form for 300 Holbrook Street in Erie, CO

D. Completed Intensive Survey Form



Document Notes

Completed Intensive Survey form for 300 Holbrook Street in Erie, CO

D. Completed Intensive Survey Form



WL 7990-09-300HolbrookSt



WL 7990-10-300HolbrookSt



WL 7990-11-300HolbrookSt



WL 7990-12-300HolbrookSt

Document Notes

Completed Intensive Survey form for 300 Holbrook Street in Erie, CO

D. Completed Intensive Survey Form



WL7990-13-300HolbrookSt

Document Notes

Completed Intensive Survey form for 300 Holbrook Street in Erie, CO

F. Nomination Form



City of Glenwood Springs, Colorado Historic Preservation Commission Local Landmark Nomination Form

Section I

Name of Property

Historic Name (if any): _____

Other Names: _____

Address of Property

address not for publication

Street Address: _____

Legal Description of Property:

Subdivision: _____ Lot: _____ Block: _____

Section: _____ Township: _____ Range: _____ (if rural or not located within a subdivision)

Maps

Include a location map on 8.5x11 inch page showing the property in relation to major streets.

Include a site plan on 8.5 x 11 inch page showing the footprint of the building if applicable

Current Owner of Property

(for properties with multiple owners, list the names and addresses of each owner on one or more continuation sheet)

Name: _____

Mailing Address: _____ Phone: _____

City: _____ State: _____ Zip: _____

Owner Consent for Nomination (attach signed consent from each owner of property – see attached form)

Preparer of Nomination

Name: _____ Date: _____

Organization: _____

Mailing Address: _____ Phone: _____

City: _____ State: _____ Zip: _____

For Official Use:

Date Application Received: _____

Historic Preservation Commission

Approval:

Denial:

Comments: _____

Signature: _____

Historic Preservation Commission Chair

*City of Glenwood Springs
Historic Preservation Commission Local Landmark Nomination
101 W. 8th Street
Glenwood Springs CO 81601
970-384-6428*

1

Document Notes

City of Glenwood Springs, Colorado Historic Preservation Commission Local
Landmark Nomination Form

F. Nomination Form

Section II

Category of Property (please check one box) **Number of Resources within Property:**

<input type="checkbox"/> Building(s)	_____ Building(s)
<input type="checkbox"/> Site	_____ Site
<input type="checkbox"/> Object	_____ Object
<input type="checkbox"/> District	_____ District
<input type="checkbox"/> Structure	_____ Structure
	_____ Total Number of Resources

Year of Construction: _____
Source of Information: _____

Original Owner: _____
Source of Information: _____

Architect, Builder, Landscape Architect, Designer (if known): _____
Source of Information: _____

Location Status:
If the property is a building, object or structure, has it been moved? Yes No
If yes:
When was it moved? _____
Where was its original location? _____

Section III

Architectural Description: If property is a building, please describe the predominate architectural style.

Narrative Description: On one or more 8.5x11 inch sheets of paper, please describe the current appearance of the property and any alterations that have occurred since its original construction.

Photographs Please attach current photographs of the property and if available, copies of historic photographs. For buildings, structures, or objects, current photographs should show the property from all directions.

*City of Glenwood Springs
Historic Preservation Commission Local Landmark Nomination
101 W. 8th Street
Glenwood Springs CO 81601
970-384-6428*

2

Document Notes

City of Glenwood Springs, Colorado Historic Preservation Commission Local
Landmark Nomination Form

F. Nomination Form

Section IV

Significance of the Property

Indicate the how the property is significant to the City of Glenwood Springs' past by checking one or more of the following:

- A** The property is associated with events that have made a significant contribution to the history of Glenwood Springs.
- B** The property is connected with persons significant in the history of Glenwood Springs.
- C** The property has distinctive characteristics of a type, period, method of construction or represents the work of a master, or possesses high artistic values.
- D** The property has yielded, or is likely to yield information important to Glenwood Springs' pre history or history (archaeological site).
- E** Other (please provide details on the significance of the property in the narrative section below).

Narrative Statement of Significance

On one or more 8.5x11 sheets of paper, please describe how this property contributes to the history of Glenwood Springs. Why should the property be landmarked?

*City of Glenwood Springs
Historic Preservation Commission Local Landmark Nomination
101 W. 8th Street
Glenwood Springs CO 81601
970-384-6428*

3

Document Notes

City of Glenwood Springs, Colorado Historic Preservation Commission Local
Landmark Nomination Form

F. Nomination Form

Section V

Bibliography

Please cite the books, articles, personal contacts, and other sources used in preparing this application.

Review Process

Return completed form to the address provided below. City staff and the Historic Preservation Commission will then be in contact to schedule a meeting for the purpose of discussing this landmark nomination.

*City of Glenwood Springs
Historic Preservation Commission Local Landmark Nomination
101 W. 8th Street
Glenwood Springs CO 81601
970-384-6428*

4

Document Notes

City of Glenwood Springs, Colorado Historic Preservation Commission Local
Landmark Nomination Form

F. Nomination Form



City of Glenwood Springs Local Landmark Nomination Owner Consent Form

Each owner of record must sign a separate form. Reproduce form as needed.

I, _____
(type or print)

owner of _____
(address)

a property that is located within the city of Glenwood Springs, Garfield County, Colorado,
certify or affirm that I am the sole owner ; partial owner ; or the legally designated
representative of the owners of the land and property indicated above.

I hereby give my written consent and approval for this property's nomination to and inclusion in
the Glenwood Springs register of local landmarks.

Signature: _____

Date: _____

*City of Glenwood Springs
Historic Preservation Commission Local Landmark Nomination
101 W. 8th Street
Glenwood Springs CO 81601
970-384-6428*

5

Document Notes

City of Glenwood Springs, Colorado Historic Preservation Commission Local
Landmark Nomination Form

G. Public Meeting on Establishing Historic District Agenda

Public Meeting for Montezuma Avenue Historic District

The Cortez Historic Preservation Board will be holding a public meeting to discuss the creation of a local historic district on Montezuma Ave. The meeting will be held on Thursday, February 12 at St. Margaret Mary Catholic Church at 6 PM in the Church Hall, which is located at 28 E. Montezuma.

This public meeting will include a presentation by Jill Seyfarth, the City's historic preservation consultant. She will explain what creating an honorary historic district would entail, and will propose 3 options for a district. The western boundary in all options is N. Chestnut St. The north and south boundaries are the alleys that are adjacent to Montezuma Avenue. There are 3 possibilities for the east boundary: the eastern boundary of the Original Townsite (219 E. Montezuma), N. Washington St., or N. Harrison St. Please attend this meeting where we will have maps to more clearly define these boundaries for a possible district.

In 2011 and 2012, the City of Cortez conducted an inventory of properties on Montezuma Ave. to determine which ones are historic. As a result of these two inventories, 61 properties were determined to be eligible for the City of Cortez Register of Historic Sites. Twenty-two owners of historic properties chose to have them listed on the City Register, which is an honorary designation only.

Due to the high number of historic properties on Montezuma, we would like to consider the possibility of forming an historic district there. However, this will only happen if there is sufficient neighborhood support. The median on Montezuma Ave. is designated as an historic site on the City Register, but the "site" includes only the median, not any of the privately owned properties on the Avenue.

For more information, contact Historic Preservation Board Chairman Linda Towle at 565-3987.

Document Notes

City of Cortez, Colorado Historic Preservation Board meeting notice considering the Montezuma Avenue Historic District.

H. Designation Letter



CITY OF BOULDER
Planning, Housing & Sustainability

1739 Broadway, Fourth Floor P.O. Box 791 Boulder, Colorado 80306
Phone: 303.441.1880 Fax: 303.441.3241

[Date]

[Property Owner]
[Address]
[City, State ZIP]

RE: Landmark Ordinance for the [Landmark Name, Landmark Address]

Dear [Property Owner],

City Council adopted Ordinance No. [Ord. Number] by a unanimous vote on [CC Date]. That ordinance designates the property at [Landmark Address] as an individual landmark under the city's Historic Preservation Code.

A copy of the City Council memo and ordinance are included for your records. A signed and completed copy of the ordinance will be available from the city's Central Records office 30 days after adoption.

As a token of the City's appreciation for the landmark designation of your property, you will be awarded a bronze plaque summarizing the property's significance. This plaque will be presented to you at the Archaeology and Historic Preservation Month Awards Ceremony next May. We will contact you in April of next year with further information on this important event.

As a designated property, any future exterior changes require review and approval through a Landmark Alteration Certificate. The work must follow the General Design Guidelines, which are available on our website, www.boulderhistoricpreservation.net. There is no cost for this review. Additionally, as the owner of a locally designated property, you are potentially eligible for Historic Preservation State Tax Credits for the rehabilitation (interior and exterior) of your building. Information on this program can be found on History Colorado's website, www.historycolorado.org/oahp/preservation-tax-credits.

If you have any questions about the landmark designation, please give me a call. Thank you for your continued efforts in preserving Boulder's heritage.

All Best,

Marcy Cameron
Historic Preservation Planner
(303) 441-3209 | cameronm@bouldercolorado.gov

encl: City Council Memorandum and Ordinance

Document Notes

City of Boulder Letter Template for Landmark Designation Ordinance

I. Certificate of Appropriateness Application

APPLICATION FOR CERTIFICATE OF APPROPRIATENESS *LONGMONT HISTORIC PRESERVATION COMMISSION*

PROPERTY

Historic Name _____
Address _____
Legal Description _____

BRIEF DESCRIPTION OF ALTERATIONS

SUBMITTAL REQUIREMENTS

- _____ One good quality photograph of the building or property as it looks today accurately representing the existing materials, colors and textures.
- _____ Photographs showing the location of the proposed alterations
- _____ Written statement describing the proposed alterations and purpose for the alterations.
- _____ 2 copies of all drawings and related materials folded to 9" x 12"
- _____ Sample or product literature of materials to be used for the alterations

OWNER CERTIFICATION

I certify that I am a person in interest and the information and exhibits submitted are true and correct to the best of my knowledge and that in filing this application, I am acting with the knowledge and consent of all persons in interest. With out the consent of persons in interest, the requested action cannot lawfully be accomplished.

Name _____
Owner(s) signature(s) _____

Address _____
Phone/Fax _____

STAFF USE ONLY

Application accepted _____ Yes _____ No
If application not accepted list missing or incomplete items
1. _____
2. _____
Date _____

Document Notes

City of Longmont Application for Certificate of Appropriateness for Longmont Historic Preservation Commission

J. Workshop Flyer

Compatible Development in Single-Family Neighborhoods



Workshop Activities

January 14, 2009

Boulder High School Cafeteria - 1604 Arapahoe Ave.

January 15, 2009

West Senior Center - 909 Arapahoe Ave.

These identical workshop activity sessions follow the recommended strategy presentation and peer panel discussion held on Monday, January 12, 2009.

5:30 - 6:00

Open House

City Staff and Consultant Team

6:00 - 6:20

Introduction

Julie Johnston, city of Boulder

Abe Barge, Winter & Company

- Workshop objectives
- Brief overview of January 12 presentation and panel
- Workshop activities to be completed

6:20 - 6:50

Workshop Activity #1 (Team)

Refined problem statement, strategy and tools

6:50 - 7:30

Workshop Activity #2 (Team)

The specific standards for consideration by Planning Board and City Council

7:30 - 7:45

Team Reports

7:45 - 8:00

Individual Worksheet

Refined problem statement, strategy and general comments

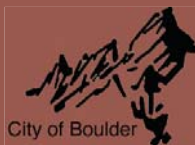

Document Notes

Flyer for Workshop for Compatible Development in Single-Family Neighborhoods in Boulder, Winter & Company, January 14th and 15th, 2009.

K. Brochure Cover

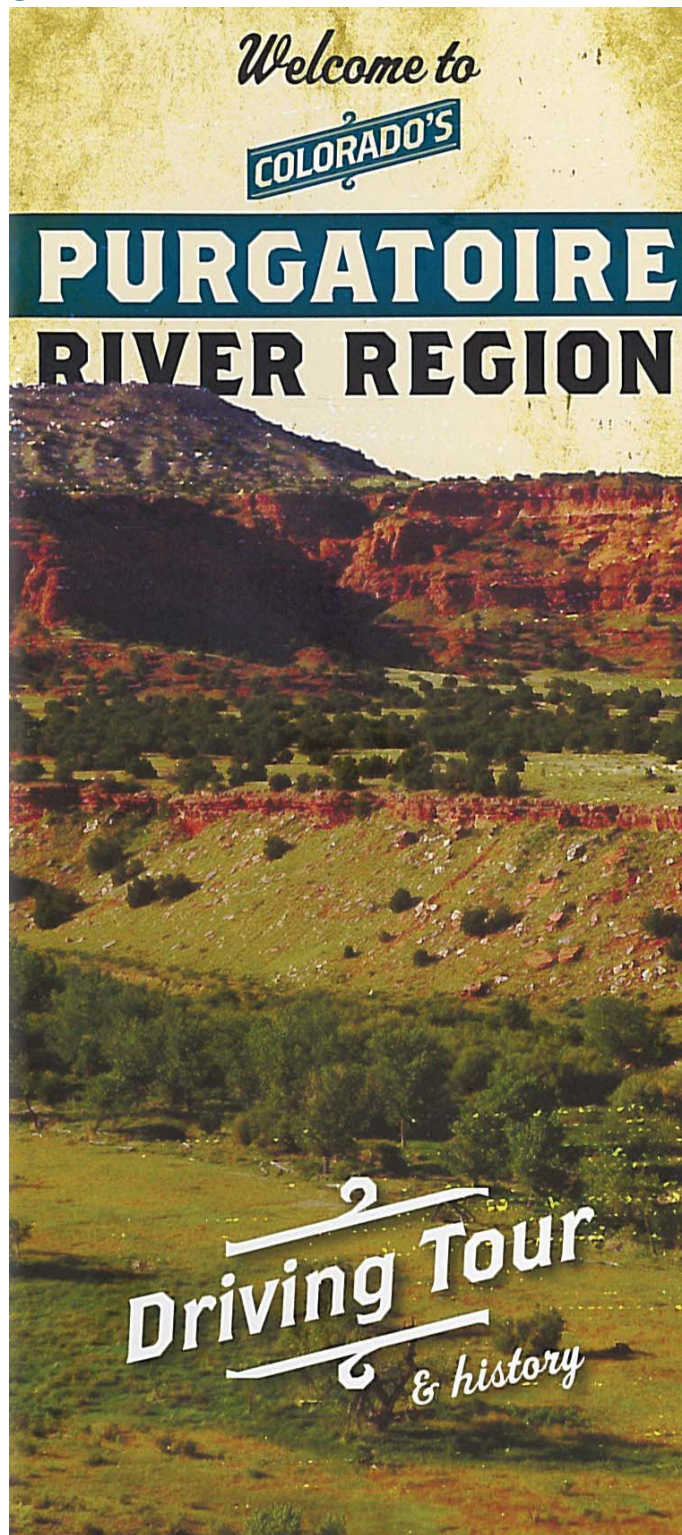

Document Notes

Purgatoire River Region Driving Tour and Brochure

L. Small Community Design Guidelines

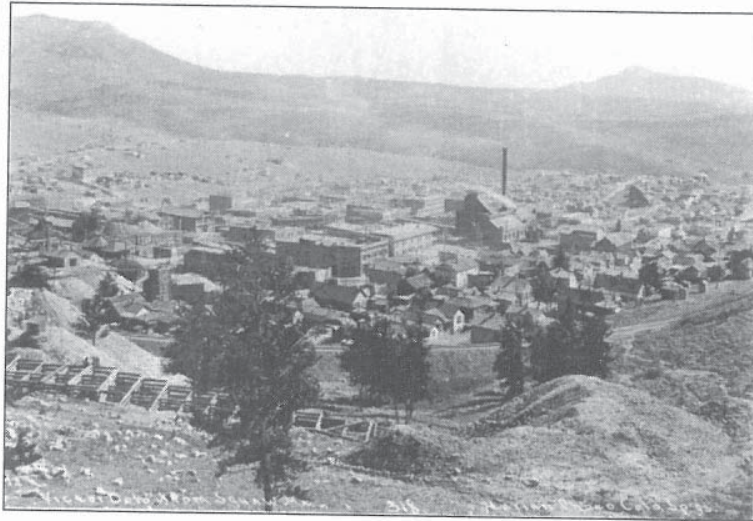

VICTOR
DESIGN GUIDELINES
HANDBOOK

A Guide to Preserving Our Architectural Heritage

Document Notes

Victor, Colorado Design Guidelines Handbook by Cathleen Norman, Susan Goldstein, and Winter & Company. To view the full document, visit: <http://bit.ly/2nwVkXi>

M. Medium Community Design Guidelines

City of Dubuque

Architectural Guidelines



February 3, 2014

Document Notes

Dubuque, IA Architectural Guidelines, Winter & Company, February 2014.

To view full document visit: <http://www.cityofdubuque.org/1881/Architectural-Guidelines>

N. Large Community Design Guidelines

OLD TOWN HISTORIC DISTRICT DESIGN STANDARDS FORT COLLINS, COLORADO



State Historical Fund, History Colorado, the Colorado Historic Project #2013-M2-032

Draft #1b November 4, 2013

Document Notes

Fort Collins, Colorado Historic District Design Standards, Winter & Company, February 2013. To view full document visit: <http://www.fcgov.com/historicpreservation/otrd-design-standards-and-guidelines.php>.

O. Annual CLG Report



Colorado Certified Local Government 2016 Annual Report

State Fiscal Year 2016: July 1, 2015 – June 30, 2016
Due Date: August 8, 2016

Please Attach All Requested Documents | Attach Additional Sheets As Needed

Name of County/Municipality:

Name of Commission Board:

Contact Name:

Contact Title:

Contact Phone:

Contact Fax:

Contact Email:

Contact Address:

City:

State: CO

Zip:

Preservation Planning & Operational Documents

In State Fiscal Year 2016, were any of the following newly developed or revised:

- 1) Preservation Ordinance (including Amendments)?
- 2) By-Laws or Administrative Rules?
- 3) Preservation Plan?
- 4) Survey Plan?
- 5) Design Guidelines:
 - a. For Entire County/Municipality?
 - b. For A Specific Neighborhood and/or District? Name of District:

An Accurately Completed Annual Report is a CLG Requirement

Document Notes

Colorado Certified Local Government 2016 Annual Report

O. Annual CLG Report

Commission or Board

- 6) Provide a list of all current Commission/Board Members. Identify any Commission/Board Members newly appointed in State Fiscal Year 2016 with an asterisk (*) and attach their resumes and/or applications. Also identify all Commission/Board Members that are professionals in preservation related disciplines with two asterisks (**) and list the profession beside their names.

- 7) If 40% of the current Commission/Board is not comprised of preservation related professionals, please describe your efforts to recruit. How will the Commission/Board seek additional expertise in the fields of architecture, architectural history or Archaeology when needed?

- 8) Please list the number of meetings and dates held in State Fiscal Year 2016:

Regular Meetings	Special Meetings	Work/Study Sessions
Total Number	Total Number	Total Number
<u>Dates</u>	<u>Dates</u>	<u>Dates</u>

- 9) List the educational/training sessions attended by Commission/ Board Members in State Fiscal Year 2016. Please list name of session or conference (list conference, not individual sessions when a conference was attended) and the name(s) of Commission/Board Member attending.
-

Document Notes

Colorado Certified Local Government 2016 Annual Report

O. Annual CLG Report

Preservation Plan, Historic Contexts and Surveys

- 10) Does your County/Municipality have a Preservation Plan or a Preservation Section in your Comprehensive Plan? If yes, when was it adopted?
- 11) Does Your Commission/Board have a Survey Plan? If yes, when was it adopted?

If no Survey Plan has been developed, please describe your plans to comprehensively survey all historic properties within your jurisdiction.
- 12) List any Historic Context Studies completed in State Fiscal Year 2016.
- 13) List any Historic Resource Surveys completed in State Fiscal Year 2016.

Designations

- 14) How many contributing resources (buildings, sites, structures, landscapes) are locally listed? This count includes ALL listings since the Commission/Board was originally formed. For Districts, count all contributing building, structures and sites individually.
- 15) How many contributing resources (buildings, sites, structures, landscapes) were listed in State Fiscal Year 2016? For Districts, count all contributing building, structures and sites individually.

Please list. For Districts, list name with number of contributing resources in parenthesis.
- 16) List National Register Nominations that for which the Commission/Board submitted comments to History Colorado in State Fiscal Year 2016.

Design Review

- 17) How many design review applications were considered by the Commission/Board for **designated** resources in State Fiscal Year 2016?
 - a. Total Reviewed
 - b. Review by Full Commission
 - c. Review by Design Review Subcommittee Only
 - d. Reviewed by Staff Only

Document Notes

Colorado Certified Local Government 2016 Annual Report

O. Annual CLG Report

- 18) How many design review applications were considered by the Commission/Board for **non-designated** resources in State Fiscal Year 2016?
- a. Total Reviewed
 - b. Review by Full Commission
 - c. Review by Design Review Subcommittee Only
 - d. Reviewed by Staff Only

Preservation Incentives

State

- 19) Does your Commission/Board review Colorado Historic Preservation Tax Credits?

- a. Residential Tax Credit Applications
 - i. Number of Part I Applications Filed in State Fiscal Year 2016
 - ii. Number of Part II Certifications Approved in State Fiscal Year 2016
 - iii. For each Part II Certification, please list:

Property Address	Total Qualified Rehabilitation Expenditures	Total Tax Credit

- b. Commercial Tax Credit Applications (Under 1990 Law)

*Commercial Tax Credits filed under 2014 Law must be reviewed through the Colorado Office of Economic Development & History Colorado

 - i. Number of Part I Applications Filed in State Fiscal Year 2016
 - ii. Number of Part II Certifications Approved in State Fiscal Year 2016
 - iii. For each Part II Certification, please list:

Property Address	Total Qualified Rehabilitation Expenditures	Total Tax Credit

- 20) Was your Commission/Board awarded a CLG Grant in State Fiscal Year 2016? (Do NOT include grants awarded in State Fiscal Year 2015, but completed in 2016.) If yes, list name of project.
- 21) Was your County/Municipality awarded any State Historical Fund Grants in State Fiscal Year 2016? (Do NOT include grants awarded in previous State Fiscal Years, but completed in 2016 or currently under review.) If yes, list name of project (s).

Document Notes

Colorado Certified Local Government 2016 Annual Report

O. Annual CLG Report

Local

- 22) Does your County/Municipality have a tax incentive program under local law for the benefit of historic properties? If yes, how many properties were assisted through this program in State Fiscal Year 2016? Please describe program.
 - 23) Does your County/Municipality have a government funded loan program under local law for the benefit of historic properties? If yes, how many properties were assisted through this program in State Fiscal Year 2016? Please describe program.
 - 24) Does your County/Municipality have a government funded grant program under local law for the benefit of historic properties? If yes, how many properties were assisted through this program in State Fiscal Year 2016? Please describe program.
 - 25) Does your County/Municipality provide for zoning variances/use allowances under local law for the benefit of historic properties? If yes, how many properties were assisted through this program in State Fiscal Year 2016? Please describe program.
 - 26) Does your County/Municipality have a government program under local law that provides for the acquisition of historic properties in whole or in part through purchase or donation? If yes, how many properties were acquired, in whole or in part, through this program in State Fiscal Year 2016? Please list the names of these properties.
-

Public Outreach & Education

- 27) Did your Board/Commission sponsor or participate in any public outreach events/meetings/tours in State Fiscal Year 2016? If yes, please describe.
 - 28) Did your Board/Commission undertake or sponsor any educational programs/workshops in State Fiscal Year 2016? If yes, please describe.
 - 29) Did your Board/Commission develop, publish or update any interpretive or tourism related materials in State Fiscal Year 2016 such as interpretive signage or walking/driving tour brochures, apps or podcasts? If yes, please describe.
-

Project Review

- 30) Did your County/Municipality comment or participate in any Section 106 Reviews as a consulting party in State Fiscal Year 2016? If yes, list name of project or property and the Federal Agency initiating the review.
-

Document Notes

Colorado Certified Local Government 2016 Annual Report

O. Annual CLG Report

Year In Review

- 31) What CLG accomplishment/achievement/event in State Fiscal Year 2016 makes the Commission/Board most proud?
- 32) Describe any problems – operational, political or financial – encountered by the CLG in State Fiscal Year 2016.
-

Plans for Upcoming Fiscal Year

- 33) Describe any planned/projected Commission/Board activities for State Fiscal Year 2017.
-

Attachment Checklist

All documents listed below are required for a complete report unless listed as "if applicable" or "if adopted". Providing a link to an online document, if downloadable, may be substituted for actual attachment of a document when available.

- Completed Annual Report
- Sample of Public Notice Announcing Commission/Board Meeting
- Sample Advertisement for New Commission/Board Members
- Resumes/Applications for New Commission/Board Members (If Applicable)
- Current Preservation Ordinance (including any Amendments)
- Current By-Laws or Administrative Rules for the Commission/Board
- Current Preservation Plan or Preservation Chapter in Comprehensive Plan (if adopted)
- Current Survey Plan (if adopted)
- List of **all** Designated Properties (from inception of local listing)
- Historic Context Surveys Completed in State Fiscal Year 2016 (if applicable)*
- Historic Resource Surveys Completed in State Fiscal Year 2016 (if applicable)*

* For all Historic Context Studies and Historic Resource Surveys previously submitted to History Colorado in State Fiscal Year 2016, a date of submission is sufficient. Resubmission of the actual document is not required.

Document Notes

Colorado Certified Local Government 2016 Annual Report